

TECHNICAL INFORMATION

Flow control techniques

Pneumatic solenoid valves may be subdivided into two categories: digital on/off solenoid valves and proportional solenoid valves.

Digital solenoid valves combine their open-closed position with an electric on-off control.

Proportional solenoid valves combine a particular position (between open and closed) in a proportional way with a tension or variable-current control device. The evolution of technology led to the development of new flow control techniques, which allow the use of digital components instead of proportional ones. These techniques, started from electronics, are PWM, PFM, PNM and PCM, besides combinations between them (Combined Techniques).

PWM Technique

PWM (Pulse Width Modulation) technique consists of the generation of a square wave of constant frequency, with variable pulse duration. The DC (duty-cycle) defined as the rate between the duration of t_p signal (which is variable) and T_o period (which is constant), expressed in percentages, is indicated as:

$$DC = t_p / T_o \times 100$$

A linear growth of the DC (duty-cycle) corresponds to a linear growth of the impulse duration. It means that a PWM control to a 2/2 normally closed (NC) solenoid valve implies a proportional variation of the passing flow, which results to be:

$$Q = Q_{nom} \times t_p / T_o$$

where t_p is variable, Q is the passing flow and Q_{nom} is the rated (maximum) flow. The flow may assume infinite values included between zero and maximum flow.

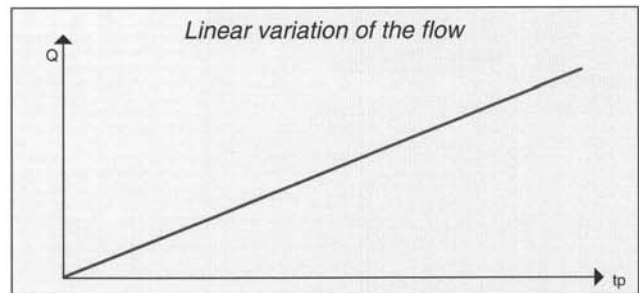
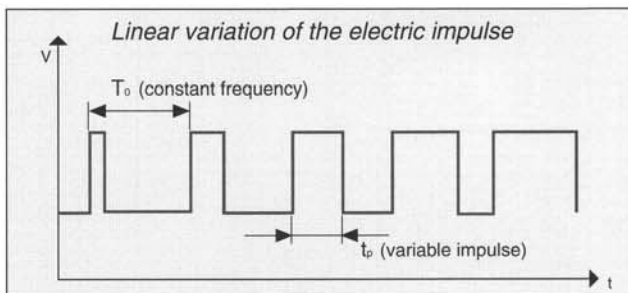

Solenoid Valves 820 - 850 - 720 (2/2) - 750 (2/2) Series

PFM Technique

PFM (Pulse Frequency Modulation) technique consists of the generation of a variable-frequency (period) square wave, with a constant impulse duration. A PFM control to a 2/2 NC solenoid valve implies a proportional variation of the maximum passing flow to frequency, i.e. in inverse proportion to T_o period:

$$Q = Q_{nom} \times t_p / T_o$$

where the period T_o is variable. The flow may assume infinite values included between zero and maximum flow.

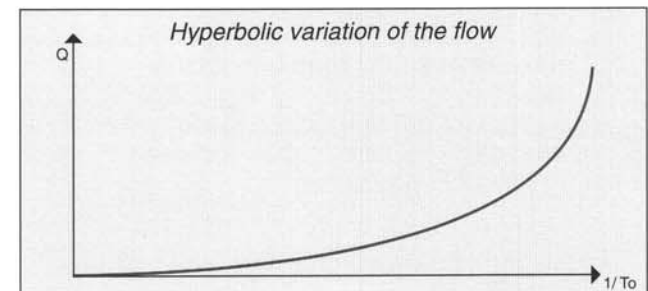
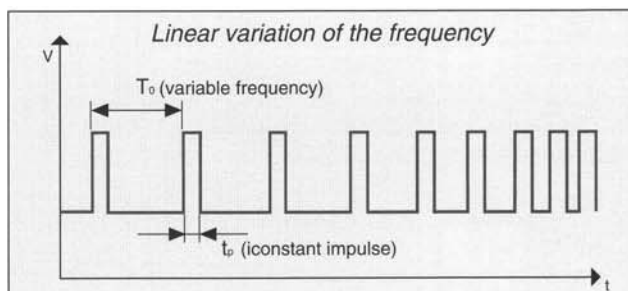

Solenoid Valves 820 - 850 - 720 (2/2) - 750 (2/2) Series

PNM Technique

PNM (Pulse Number Modulation) technique is based on the features of multiple shutter valves of 750 and 850 Series. It consists of the generation of on-off control groups. This means that a PNM control (variable from 0 to n), applied to an n shutter group of equal flow, implies a proportional variation to n of the passing flow. The flow results as:

$$Q = Q_n \times n$$

where Q_n is the rate of flow of only a shutter. The rate of flow may assume n values included between zero flow and maximum flow. When $n = 8$ the achievable values are just 8.

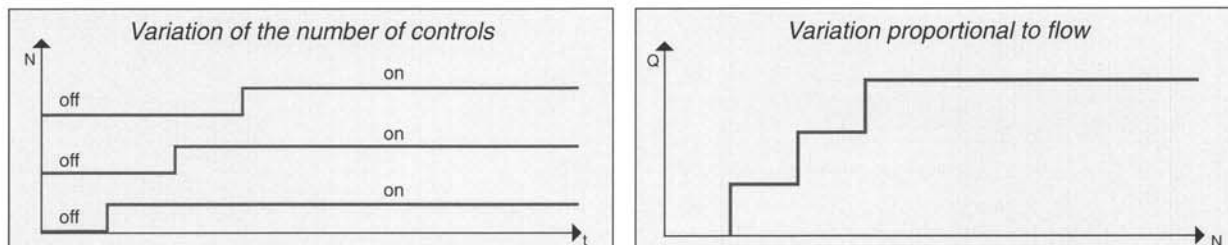

Solenoid Valves 850 - 750 (2/2) Series

PCM Technique

PCM (Pulse Code Modulation) is based on the features of the multiple shutter valves of 850 PCM Series. It resumes the principles of binary codification, typical of computers, and it consists of generating on/off control groups with shutters having different flows. This means that a PCM control of binary type (variable from 0 to n) to a group of n shutters NC 2/2 having different flow, which is determined according to 2 (SV 1=1; SV 2=2; SV 3=4; SV 4=8...; SV 8=128) implies a variation of the passing flow proportional to n. The flow results to be the summation:

$$Q = \sum_n (Q_n)$$

Where Q_n is the flow of the solenoid valve n and n is expressed in a binary way. The flow may assume 2^n values, included between zero flow and maximum flow. Consequently, in the $n = 8$ case, the assumable values are 256.

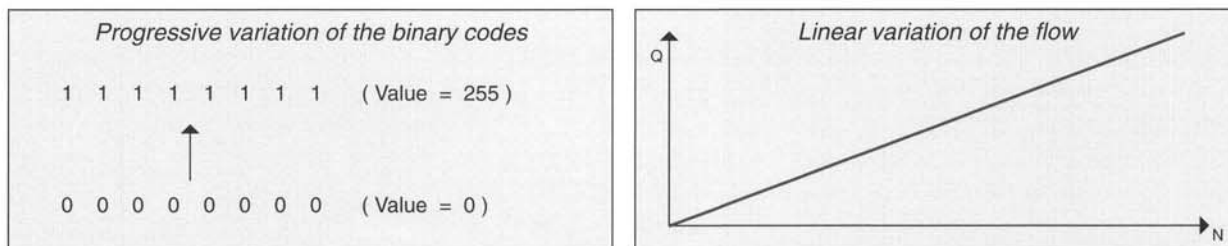

Solenoid Valves 850 PCM Series

Combined Techniques

The employment of combined techniques may usefully result in joining the features of the single techniques, which have been previously illustrated. The resulting combinations allow a greater level of accuracy in the flow control. The following example displays the advantages of the combined techniques employed on a solenoid valve having multiple shutters.

Kind of control: fine regulation of the flow on multiple shutter solenoid valves

Type of valve: MX 851.900 (1 outlet - 9 independent shutters)

Employed techniques: 8 shutters controlled with PNM technique - 1 shutter controlled with PWM technique

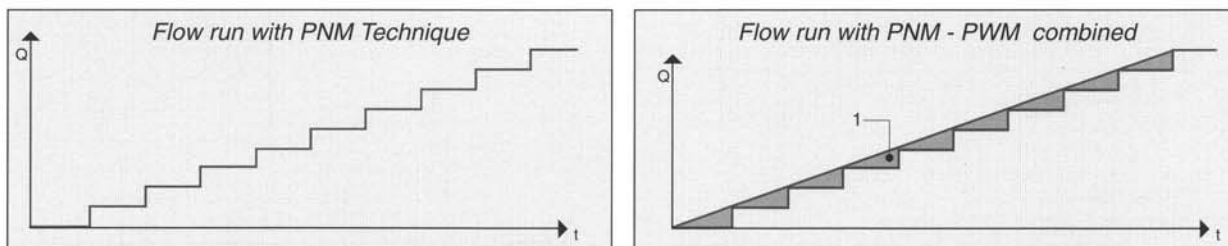

Every step corresponds to an intervention of shutter. A proportional variation of the flow is obtained.

1) Intervention areas of the 9th with PWM technique. A linear variation shutter controlled is obtained.

Solenoid Valve 850 - 750 (2/2) Series

ON - OFF control Technique with double level of tension

One of the peculiar characteristics of Matrix technology is the exponential increment of the energy efficiency as regards the magnetic system during either the opening phase (NC, Function) or closing phase (NO, Normally Open, Function) of the solenoid valve (Picture 1). Said characteristics derive from the progressive reduction of the magnetic gap, reaching zero-value when the solenoid valve is completely open (NC Function) or completely closed (NO Function) (See Picture 3 at "Matrix technology" paragraph).

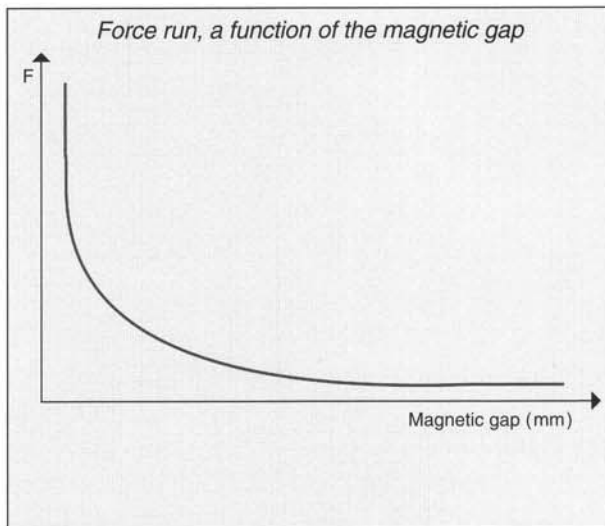

Picture 1

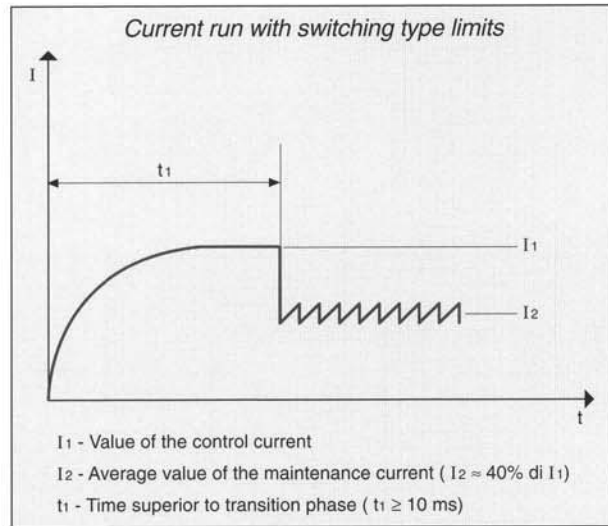

Picture 2

Therefore, the maintenance of the open (or closed) solenoid valve condition requires a considerably lower energy level, compared with the transition phase, during which the change of condition takes place. Said transition phase coincides with the response time of the solenoid valve. Therefore, after this period of time is possible to restrict the dissipated power, reducing the control tension or the relative current (for example from 24 VDC to 14 VDC).

The incidence of said reduction of the dissipated power by the solenoid valve, in the typical case of 750.....JJ, Series is the following:

Dissipated power with 24 VDC tension (single coil)	1.9 W
Dissipated power with 14 VDC tension (single coil)	0.65 W

The reduction of the control tension may be realized through the hardware (see tension reductor PRB in chapter "Electronic Driver Boards"). In this case, the circuit occurs when the control time is higher than 100 ms, inserting a resistance in series with the coil of the solenoid valve. Therefore, there is a reduction of the feeding tension. The maximum operation frequency of the solenoid valve, using the PRB circuit is limited to 20 Hz. The reduction of the relative current may be realized through the ON-OFF control at high frequency (it is typical at 20 KHz), named Switching, and through a suitable duty-cycle (Picture 2).

This kind of current reduction with switching control is present in the Universal Driver Board with 8-channel UDB (see "Electronic Driver Boards").

The advantages coming from this control technique are particularly evident in the case of solenoid valves used with high duty-cycles and high ambient temperature. The reduced absorption, and the consequent low power, dissipated by the solenoid valve drastically reduce the working temperature of the elastomers. In this way, from a dynamic point of view, the ideal working conditions are assured.

Moreover, said control technique assures a remarkable energy saving, particularly evident in the case of multiple applications.

TECHNICAL INFORMATION

Matrix Technology

Matrix pneumatic technology uses two highly innovative principles:

- the absence of internal friction during the shutter opening and closing phases;
- the modular architecture, allowing the assembly of several shutters in a sole body.

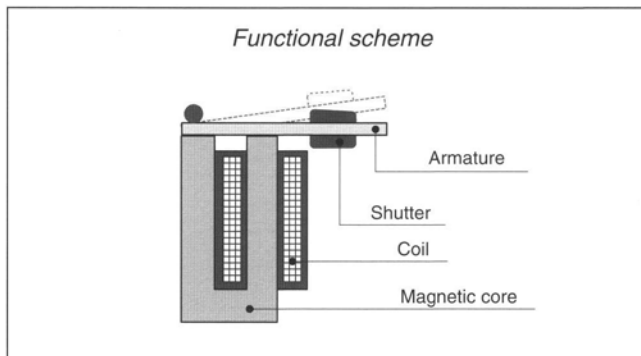

Picture 3

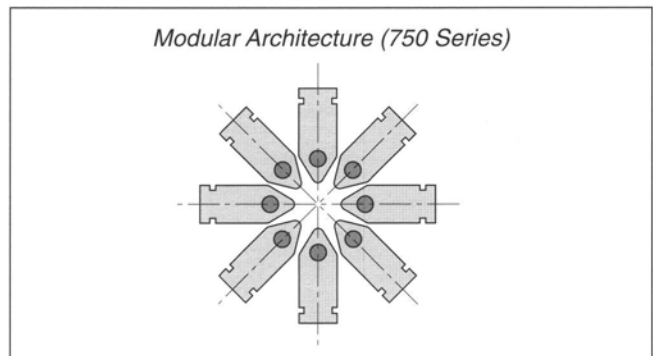

Picture 4

The traditional technologies, employed in solenoid valves, both slide and shuttered valves, suffer in different ways, because of the inertial forces of their mechanical components, thermal exchanges, trimmings frictions, high temperatures, caused by the electric windings.

The absence of friction (Picture 3), combined with the reduction of the moving mass, as well as the employment of material with energetic high efficiency gives the pneumatic control extremely fast response times and increased precision and repetitiveness. A remarkable economy in work (energy absorption and compressed air use), high reliability and product life superior to 500 million cycles per each single shutter. Further, remarkable advantages, assured by Matrix technology are a high insensibility to ranges of temperature (ambient temperature) and to vibrations and accelerations.

Working characteristics are connected with the type of control, which, as shown in the chapter "Speed-up control Techniques", determines the response times. Solenoid valves, in standard version, i.e. equipped with traditional on/off control, have a response time better than five ms on opening, and better than two ms on closing (full frequency of working 200 Hz). On the contrary, speed-up controlled solenoid valves have a response time both on opening and on closing better than 1 ms, with a maximum frequency of working of 500 Hz. Their increase (phase displacement) and reduction as regards the control are insignificant (Picture 5).

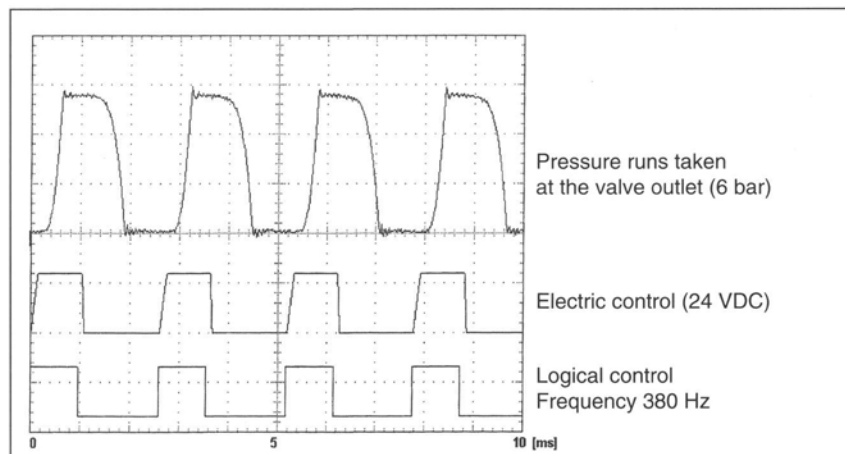

Picture 5 - MX 821. The plot effected with high-frequency control shows the absolute precision and repetitiveness of the pneumatic signal together with its perfect coincidence with the electric signal.

Among the newest techniques of high-, low frequency control, such as PWM and PFM techniques, the former prevails for a number of reasons. In fact, this technique is easier to implement in hardware and software ways. Generating a square wave at constant frequency and with a variable signal is indeed a very simple operation. The PWM technique is linear for system controls; it is easy to manage through both the electronics and the programmable controls. It is adaptable to a great number of systems; it is a well-known technique, widely spread also in the electronic field. For example, all switching feeders function with PWM technique. Besides, the PWM control of a digital solenoid valve transforms it into a solenoid valve proportional in flow, only by changing the pulse duration.

Since the higher are readiness and precision of a system, the higher results the control speed (frequency). Consequently, the PWM control technique requires unusual technical features for the elements to be controlled. Just like computers, where their global speed is due to the operating rate (frequency) of the interior clock. Namely, said technical features are characterized by:

- extremely reduced response times;
- very long operation life;
- insensibility to work at high speed.

The importance of the response times is fundamental. Actually, a short response time allows to obtain very 'steep' rising and fall fronts, similar to a logic drive given by the control, without any phase lag. Moreover, it is then possible to work at high or low speed (frequency) and in advance to determine the effective flow rates produced by the control. In this case, the solenoid valve may be considered as a logic element with immediate commutation. The response time determines also the exploitation percentage of the duty-cycle: short response times allow utilizing practically all the range of duty-cycle, for example 5 to 100%. On the contrary, long response times, the period being equal, allow using short ranges of duty-cycles. Therefore, the period being equal also in that case, a larger modulation capacity and, in the case of control application, an action of greater precision and speed are derived.

The modular architecture (picture 4), i.e. the second important innovation offered by Matrix technology, allows a surprising variety of new applicative solutions, comprising the new techniques of flow control like PNM, PCM and combined flow control techniques. All the multiple solenoid valves (850 and 750 Series) are modular. They are equipped with (single or assembled) electrical controls and at the outlets (single or assembled), through the interchangeable interface flanges with either 1-3-9 outlets (850 Series) or 1-2-4-8 outlets (750 Series). When the response times are equal, the variation of the flow rate is proportional. Furthermore, in the multiple solenoid valves the pneumatic feeding (supply) and outlet are conveyed. In this way, they may be assembled on manifolds and, consequently, the plants may be simplified and rationalized.

Therefore, 850 Series is characterized by models having 1, 3, 9 electrical controls, likewise 750 Series is characterized by models equipped with 1, 2, 4, 8 electrical controls.

The combination between the number of electrical controls and the number of outlets generates a wide range of applicative variants, some application examples of which are here supplied:

- 850 2/2 Series, 1 outlet - 9 controls version

Variable flow path section; flow rate proportional to the number of controls; nine flow rate levels.

- 850 2/2 Series, 1 outlet - 1 control version

High flow rate (to 1600NI/min at 6 bar rel.); response times lower than 1 ms in speed-up versions; actuation speed higher than 500 Hz.

- 750 3/2 Series, 8 outlets - 8 controls version

Eight 3/2-solenoid valves, integrated in a single body of reduced size, separately controlled.

- 750 5/2 Series, 8 outlets - 4 controls version

Allows to control separately four double acting cylinders.

- 750 2/2 - 3/3 Series, multifunction, 4 outlets 2/2 NC - 8 controls version

Allows the control of four single acting cylinders as well as the control with PWM pressure technique in two pneumatic chambers with automatic system draining.

- 750 3/3 Series, closed centres, 4 outlets 2/2 NC and NO - 8 controls version

Allows the pressure control inside four pneumatic rooms, managing the system filling, maintenance, and draining functions.

In short, it appears evident the innovative aspect of the modular architecture, which allows to settle, in an only small-sized volume, an almost limitless range of integrated pneumatic functions.

TECHNICAL INFORMATION

Rules for use not in accordance with the instructions

The general characteristics of all models and their condition of use are referred to in the catalogue pages. When a correct condition of use may be guaranteed, it is necessary to follow the undermentioned instructions. The non-observance of said instructions may generate a quick decay of the original characteristics of the product or irreversible damages, which may compromise its correct working.

1. Use of non stabilized tensions (except speed-up models)

Tension valves higher than limits, indicated in the use conditions may generate damages to elastomers and coils. In such a case you must provide for the following protections:

- a) Tension stabilizer;
- b) Step-down transformer circuit (PRB);
- c) Control circuit with double tension level.

2. Use with ambient high-temperature

An environmental high-temperature (over 50°C), combined with long actuation times and without an air passing may generate damage to both elastomers and coils. In such a case you must provide as follows:

- a) Assure the solenoid valve of a suitable ventilation;
- b) Install a tension reducer circuit (PRB) or make use of a control circuit with double tension level (except the speed-up model).

3. Continuous actuation (ED 100% models)

According to the models, said use, particularly when it is combined with such conditions as in 1 and 2, may generate damages both to elastomers and coils. In such a case you must provide as follows:

- a) Avoid to install the solenoid valve near a heat source;
- b) Assure the solenoid valve of a suitable ventilation;
- c) Install a tension reducer circuit (PRB) or use a control circuit with a double tension level (except the speed-on models).

4. Use of non in accordance fluid

Matrix solenoid valves require no lubrication. The insert in the solenoid valve of lubricating grease and oil may produce a decay of the functional features. Lubricating oils combined with liquid paraffin, solvents or some other chemical products may alter both conformation and functionality of the elastomers, provoking flow rate reductions and cutting the actuation times. It is recommended to assure a suitable drying system and fluid filtering, and avoids the introduction in the pneumatic circuit of lubricants and agents non compatible with NBR (Nitrile-butadiene rubber) introduction in the pneumatic circuit.

5. Use of conic fittings and/or dopes

It is recommended, when the solenoid valve is not provided with it, the use of conic fittings, equipped with cylindrical thread, provided with O-Rings or washers. The use of conic fittings and/or dopes may compromise the correct working of the solenoid valve.

When it is not possible to assure a suitable protection level, it is recommended to use models equipped with a HNBR actuators, available in the 860, 720 and 750 Series.