

Compact, high-speed, multifunction solution

Reach high accuracy and multifunction with microcomputers

Quick-response micro processing sensor chip

Stainless steel body

■ Applicable fluids/Flow rates

AIR **N₂**
0.015 to 50 l/min

Ar
0.015 to 50 l/min

O₂ **13A** **CH₄** **C₃H₈**
0.015 to 10 l/min

H₂ **He**
0.06 to 20 l/min

■ Weight: 480 g

Rectifying ensures low-pressure loss and realizes repeatability

Resin body

■ Applicable fluids/Flow rates
0.015 to 100 l/min

■ Weight: 200 g

Ultimate ideal multi-functions flow controller

Small size flow controller

FCM Series

Refrigerating type dryer
Desiccant type dryer
High polymer membrane dryer
Air filter
Auto. drain / others
F.R.L (Module unit)
F.R.L (Separate)
Compact F.R.
Precise regulator
F.R.L. (Related products)
Clean F.R.
Electro pneumatic regulator
Air booster
Speed control valve
Silencer
Check valve / others
Joint / tube
Vacuum filter
Vacuum regulator
Suction plate
Magnetic spring buffer
Mechanical pressure SW
Electronic pressure SW
Contact / close contact conf. SW
Air sensor
Pressure SW for coolant
Small flow sensor
Small flow controller
Flow sensor for air
Flow sensor for water
Total air system
Total air system (Gamma)
Ending



Small Size Flow Controller FCM Series. Combining small size flow sensor FCM and small solenoid valve technology. High performance and cost efficiency incorporated in sensor, proportional control, and valve functions enable use with different applications.

New Compatible with different fluids

Hydrogen and helium are added to the types of gas that this controller handles, including air, nitrogen, argon, oxygen, methane, and propane. This controller can be used with a diverse range of applications.

Low differential pressure model

The flow rate of combustion gas with low supply pressure is controlled, such as for controlling burner flame.

Compact and lightweight

Just 70 x 70 x 30 (H x D x W), this controller is installed in small spaces or movable sections, enabling equipment to be downsized and lightened.

Volume **30%**
Weight **20%**

compared to conventional model



0.5 secs high-speed control

The platinum sensor chip with silicon micromachining is capable of 0.5 secs high-speed control. This controller is used for different applications.

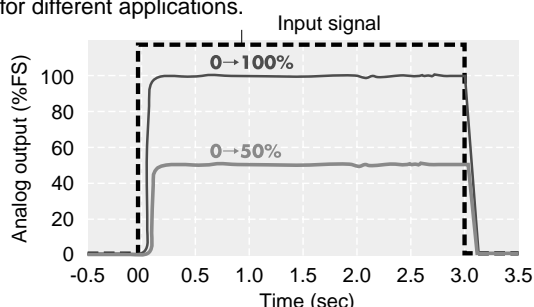

Dedicated power not necessary

This controller uses a 24 VDC power supply, and is operated with a general-purpose single power supply.

Highly reliable flow control

CKD's original rectifying mechanism improves repeatability affecting flow control.

Repeatability $\pm 1\%$ FS
Accuracy $\pm 3\%$ FS

RoHS Directive-compliant **RoHS**

All substances, such as lead and hexavalent chrome, that could adversely affect the global environment have been eliminated from materials used in this controller.

Digital display for easy confirmation of control

- The flow rate is shown on a 3-digit display.
- Errors and the output state (switch output ON-OFF) are displayed.

Output display 3-digit number LED display



A top/bottom-reversed display is selected based on the installation direction (option)

Parallel input is standard

Control is possible with parallel input -- PLC, etc., ON/OFF signal, 10-bit resolution 1024. Analog input/output devices, such as D/A converters, are not required.



Realize multi-functions with microcomputer

- **Error display**
Error occurrence is indicated with displays and electric signals.
- **Zero span adjustment**
The input signal's zero span is adjusted based on the application.
- **Preset input**
When four random flow rate points are set, the flow rate is controlled by inputting a 2-bit signal from an external source (signals from PLC, etc.).
- **Direct memory**
Even without input signals from an external source, control flow rate is freely adjusted with the product's operation keys.
- **Switch output**
A switch output using flow rate upper/lower limit settings is incorporated. (Integrated overcurrent protection)
- **Flow rate integrator function**
A flow rate integration display (maximum 6 digits) and integrating pulse output are possible.
- **Automatic shutoff**
If an emergency, such as an error occurs, the valve is automatically shut off.

Refrigerating type dryer
Desiccant type dryer
High polymer membrane dryer
Air filter
Auto. drain / others
F.R.L. (Module unit)
F.R.L. (Separate)
Compact F.R.
Precise regulator
F.R.L. (Related products)
Clean F.R.
Electro pneumatic regulator
Air booster
Speed control valve
Silencer
Check valve / others
Joint / tube
Vacuum filter
Vacuum regulator
Suction plate
Magnetic spring buffer
Mechanical pressure SW
Electronic pressure SW
Contact / close contact cont. SW
Air sensor
Pressure SW for coolant
Small flow sensor
Small flow controller
Flow sensor for air
Flow sensor for water
Total air system
Total air system (Gamma)

Ending

Small size flow controller



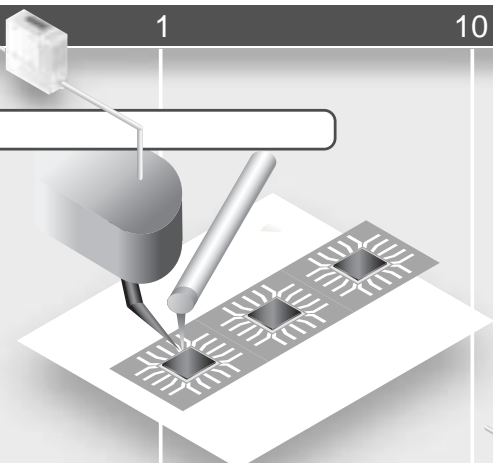
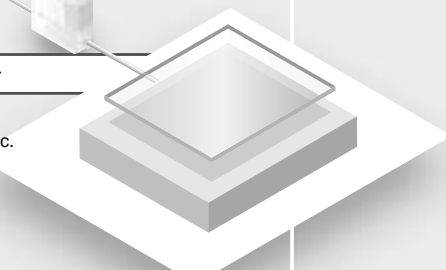
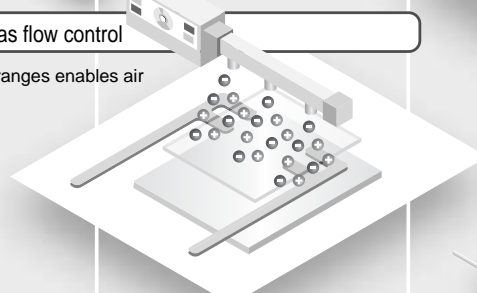
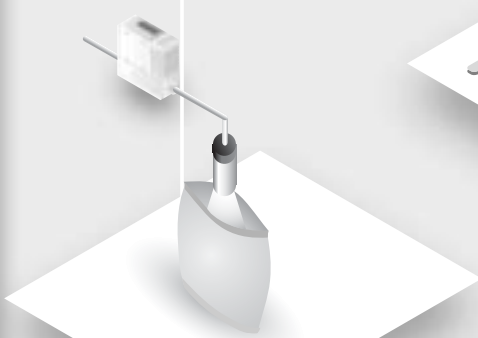
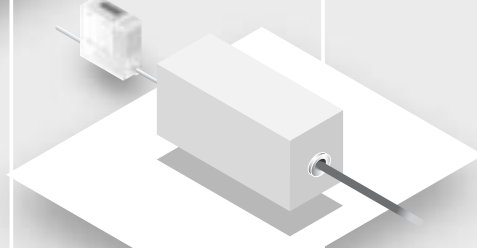
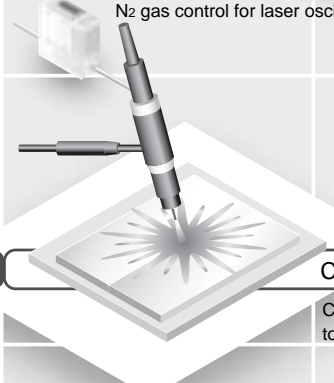
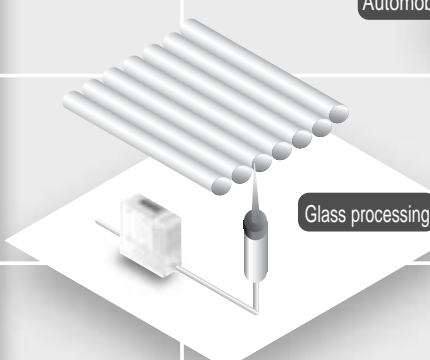

Useful in different fields

This small size flow controller is used for different applications including machinery, automobile, precision device fields, and advanced fields such as semiconductors and biotechnology, medicine and food.















Refrigerating type dryer
Desiccant type dryer
High polymer membrane dryer
Air filter
Auto. drain / others
F.R.L (Module unit)
F.R.L (Separate)
Compact F.R.
Precise regulator
F.R.L (Related products)
Clean F.R.
Electro pneumatic regulator
Air booster
Speed control valve
Silencer
Check valve / others
Joint / tube
Vacuum filter
Vacuum regulator
Suction plate
Magnetic spring buffer
Mechanical pressure SW
Electronic pressure SW
Contact / close contact conf. SW
Air sensor
Pressure SW for coolant
Small flow sensor
Small flow controller
Flow sensor for air
Flow sensor for water
Total air system
Total air system (Gamma)
Ending

	Flow (ℓ/min) 0.1	1	10	100
Applicable fluids	<p>Semiconductor Wire bonding</p> <p>Ideal for wire bonding tension control requiring high accuracy.</p> 			
	<p>Liquid crystal Glass floating transfer</p> <p>Ideal for floating (non-contact) transfer of large FPD glass, etc.</p> 			
Dry air	<p>Liquid crystal Ionizer purge gas flow control</p> <p>Compatibility with different flow rate ranges enables air flow rates to be controlled.</p> 			
	<p>Foods Filling package</p> <p>Ideal for adding inert gas for food packages, etc.</p> 			
N ₂	<p>Semiconductor Purge gas flow control</p> <p>Compatibility with different flow rate ranges enables flow rates of purge gas, etc., to be controlled.</p> 			
	<p>Automobile, etc. Control of argon gas flow for welding</p> <p>Compatibility with different flow rate ranges enables to control argon gas flow for welding.</p> 			
Ar	<p>Glass processing Burner flame control</p> <p>The low-pressure gas supply enables burner flame, etc., to be controlled.</p> 			
	<p>O₂ Combustion gas</p>			
O ₂	<p>H₂</p>			
	<p>H₂</p>			

Applicable fluids / flow control ranges

Model no.	Applicable fluids	Flow control range (ℓ /min.)					Body material	Port size	
		0.01	0.1	1	10	100			
FCM-9500 AI	AIR Air N₂ Nitrogen	[Bar chart: 0.01 to 0.1]					0.015 to 0.5	Resin 	Resin φ 6 push-in φ 8 push-in
FCM-0001 AI		[Bar chart: 0.01 to 0.1]					0.03 to 1		
FCM-0002 AI		[Bar chart: 0.01 to 0.1]					0.06 to 2	SUS 	SUS Rc1/4 9/16-18 UNF
FCM-0005 AI		[Bar chart: 0.01 to 0.1]					0.15 to 5		
FCM-0010 AI		[Bar chart: 0.01 to 0.1]					0.3 to 10		
FCM-0020 AI		[Bar chart: 0.01 to 0.1]					0.6 to 20		
FCM-0050 AI		[Bar chart: 0.01 to 0.1]					1.5 to 50		
FCM-0100AI (only resin)		[Bar chart: 0.01 to 0.1]					3 to 100		
FCM-9500 AR	Ar Argon	[Bar chart: 0.01 to 0.1]					0.015 to 0.5	SUS 	Rc1/4 9/16-18 UNF
FCM-0001 AR		[Bar chart: 0.01 to 0.1]					0.03 to 1		
FCM-0002 AR		[Bar chart: 0.01 to 0.1]					0.06 to 2		
FCM-0005 AR		[Bar chart: 0.01 to 0.1]					0.15 to 5		
FCM-0010 AR		[Bar chart: 0.01 to 0.1]					0.3 to 10		
FCM-0020 AR		[Bar chart: 0.01 to 0.1]					0.6 to 20		
FCM-0050 AR		[Bar chart: 0.01 to 0.1]					1.5 to 50		
FCM-9500 O ₂ /LN/C1/C3	O₂ Oxygen 13A City gas CH₄ Methane C₃H₈ Propane	[Bar chart: 0.01 to 0.1]					0.015 to 0.5	SUS 	Rc1/4 9/16-18 UNF
FCM-0001 O ₂ /LN/C1/C3		[Bar chart: 0.01 to 0.1]					0.03 to 1		
FCM-0002 O ₂ /LN/C1/C3		[Bar chart: 0.01 to 0.1]					0.06 to 2		
FCM-0005 O ₂ /LN/C1/C3		[Bar chart: 0.01 to 0.1]					0.15 to 5		
FCM-0010 O ₂ /LN/C1/C3		[Bar chart: 0.01 to 0.1]					0.3 to 10		
FCM-0002 H ₂ /HE	H₂ Hydrogen He Helium	[Bar chart: 0.01 to 0.1]					0.06 to 2	SUS 	Rc1/4 9/16-18 UNF 1/4 inch Double barbed joint 1/4 inch JXR male joint
FCM-0005 H ₂ /HE		[Bar chart: 0.01 to 0.1]					0.15 to 5		
FCM-0010 H ₂ /HE		[Bar chart: 0.01 to 0.1]					0.3 to 10		
FCM-0020 H ₂ /HE		[Bar chart: 0.01 to 0.1]					0.6 to 20		

I/O specifications

Input	Model no.	Output		
		Output method	Specifications	Error output
 Analog: 0-10V  Preset: 4 points (2 bit) (Note)	FCM-**-*0AN	 Analog	1-5V	NPN
	FCM-**-*0AP			PNP
	FCM-**-*0SN	 Switch	NPN	NPN
				PNP
 Analog: 0-5V  Preset: 4 points (2 bit) (Note)	FCM-**-*1AN	 Analog	1-5V	NPN
	FCM-**-*1AP			PNP
	FCM-**-*1SN	 Switch	NPN	NPN
				PNP
 Analog: 4-20mA  Preset: 4 points (2 bit) (Note)	FCM-**-*2AN	 Analog	1-5V	NPN
	FCM-**-*2AP			PNP
	FCM-**-*2SN	 Switch	NPN	NPN
				PNP
 Parallel: 10bit	FCM-**-*PAN	 Analog	1-5V	NPN
	FCM-**-*PAP			PNP
	FCM-**-*PSN	 Switch	NPN	NPN
				PNP

(Note) Preset 8-point (3-bit) input is used customized. (The external integration reset signal input cannot be used.) Contact your CKD Sales Office for details.

Refrigerating type dryer
Desiccant type dryer
High polymer membrane dryer
Air filter
Auto. drain / others
F.R.L. (Module unit)
F.R.L. (Separate)
Compact F.R.
Precise regulator
F.R.L. (Related products)
Clean F.R.
Electro pneumatic regulator
Air booster
Speed control valve
Silencer
Check valve / others
Joint / tube
Vacuum filter
Vacuum regulator
Suction plate
Magnetic spring buffer
Mechanical pressure SW
Electronic pressure SW
Contact / close contact cont. SW
Air sensor
Pressure SW for coolant
Small flow sensor
Small flow controller
Flow sensor for air
Flow sensor for water
Total air system
Total air system (Gamma)

Ending

Small size flow controller



Flow controller

Safety precautions

Always read this section before starting use.
Refer to Intro 67 for general precautions.

Small size flow controller FCM Series

Design & Selection

1. Working fluid

DANGER

■ Do not feed gas at the explosion limit. There is a risk of explosion.

■ Before using hydrogen, be sure to purge piping with inert gas such as nitrogen or argon. Otherwise explosions could occur.

■ Do not feed oxygen gas to wetted sections that are not oil-treated. There is a risk of fire. Even if the product has oil treatment, if gas other than oxygen gas has passed even once, do not use the product for oxygen gas.

WARNING

■ This product cannot be used as a business meter. This product does not comply with Measurement Laws, and cannot be used for commercial business.

■ This product is for use with gases indicated on the model. Use of noncompatible fluids lowers product accuracy and controllability. If hydrogen or helium gas is passed to a series not designated for these, the sensor safety circuit may prevent operation. (If the safety circuit operates, the flow cannot be measured or controlled until power is turned off.)

■ When mixing hydrogen or helium with another gas, be sure to note reverse gas flow. If hydrogen or helium is passed to a series not designated for these, the sensor safety circuit may prevent operation. (If the safety circuit operates, the flow cannot be measured or controlled until power is turned off.) When shutting off gas, provide shutoff valves and shut off each gas separately as shown below to prevent gas from flowing in reverse.

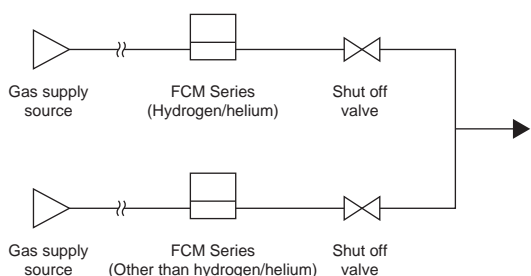

■ Prevent entry of foreign matter into this product.

If foreign matter gets into this product (dirt, water, or oil mist into pipes), accuracy and controllability could drop or the product could fail.

If foreign matter could enter the product, install a filter, dryer, or oil mist filter upstream from the product.

● The mesh provided in this product is used to rectify the flow in pipes. It is not a filter for removing foreign matter.

● Compressed air from the compressor contains drainage (water, oxidized oil, foreign matter, etc.), so install a filter, air dryer, and oil mist filter (microalescer) upstream from the product.

<Recommended circuit>

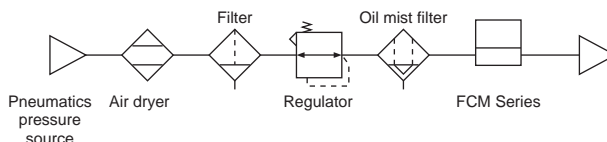

● When using a valve on the primary side of this product, only use an oil-prohibit specification valve. This controller could malfunction or fail if subject to splattering grease or oil, etc.

■ When using this controller for liquefied gas such as propane gas, evaporate the gas. This controller could fail if liquefied gas is fed.

■ When using this product to control burner air-fuel ratio, take measures in the design stages to prevent backfire, and to prevent adverse effect to this product even if a backfire should occur. A rise in the pipe's internal pressure and flame caused by a burner's backfire could damage this product.

Refrigerating type dryer
Desiccant type dryer
High polymer membrane dryer
Air filter
Auto. drain / others
F.R.L. (Module unit)
F.R.L. (Separate)
Compact F.R.
Precise regulator
F.R.L. (Related products)
Clean F.R.
Electro pneumatic regulator
Air booster
Speed control valve
Silencer
Check valve / others
Joint / tube
Vacuum filter
Vacuum regulator
Suction plate
Magnetic spring buffer
Mechanical pressure SW
Electronic pressure SW
Contact / close contact conf. SW
Air sensor
Pressure SW for coolant
Small flow sensor
Small flow controller
Flow sensor for air
Flow sensor for water
Total air system
Total air system (Gamma)
Ending

Design & Selection

2. Working environment

⚠ WARNING

- **Corrosive environment**
Do not use this product in an environment containing corrosive gases such as sulfurous acid.
- **Ambient temperature, fluid temperature**
Keep the ambient temperature and fluid temperature within 0 to 50°C.
Even if the temperature is within the specified range, do not use this product if the ambient temperature and fluid temperature could suddenly change and cause dew to condense.
- **Guaranteed withstanding pressure and operating pressure difference range**
Using this product at a level exceeding the guaranteed withstanding pressure and operating pressure difference could cause damage. Follow the specified range.
- **Drip-proof environment**
This product's protective structure is IP40 or equivalent. Do not install it where it could be subject to water, salt, dust, or cutting chips, or a compressed or decompressed environment. This product cannot be used where the temperature changes sharply or in a highly humid environment as dew condensation in the product could cause damage.
- **This product's solenoid proportional valve does not have a complete close-stop.**
If a complete close-stop is required, provide a separate external shutoff valve.
When the external shutoff valve is closed, wait with this product's valve fully closed (set flow rate: zero). If this product is left in normal control while this external shutoff valve is closed, an instant overflow could occur when the external shutoff valve is opened.
When using for applications that turn ON/OFF at a high frequency, the life of the proportional valve may be shortened depending on use. Contact CKD when using for applications that turn ON/OFF at a high frequency.
- **Do not install this product at a place that moves or vibrates.** Vibration or impact could cause this controller to malfunction.

⚠ CAUTION

- **Check the leakage current to prevent malfunction caused by current leaking from other controllers.**
When using a programmable controller, etc., the leakage current could cause this product to malfunction.

- **Due to wiring, the current input power ground and signal common are the same.**
When driving several of these products with one PLC and D/A unit, depending on the D/A unit's circuit, the correct signal may not be input because of wiring problems. Consult with the PLC maker before using.
- **Current input is used with input signal 1-5 V, but unlike other voltage input, the input impedance is small at 250Ω, so a signal generator that matches this impedance must be used.**
- **Monitor the pipe's pressure loss**
When piping this product, check that the differential pressure between the upstream side and downstream side is within the operating pressure difference range (refer to pages 1343, 1345). Controller may not operate properly if used outside of the operating pressure difference range. Operation may not be as expected if there is an orifice or restriction on the secondary side (downstream) of the product. Care must be taken.

3. Flow unit

⚠ CAUTION

- **This controller's flow rate is measured with mass flow not affected by pressure. The unit is ℓ/min., that is the mass flow converted to volumetric flow at 20°C 1 barometric pressure (101 kPa).**

Refrigerating type dryer
Desiccant type dryer
High polymer membrane dryer
Air filter
Auto. drain / others
F.R.L. (Module unit)
F.R.L. (Separate)
Compact F.R.
Precise regulator
F.R.L. (Related products)
Clean F.R.
Electro pneumatic regulator
Air booster
Speed control valve
Silencer
Check valve / others
Joint / tube
Vacuum filter
Vacuum regulator
Suction plate
Magnetic spring buffer
Mechanical pressure SW
Electronic pressure SW
Contact / close contact cont. SW
Air sensor
Pressure SW for coolant
Small flow sensor
Small flow controller
Flow sensor for air
Flow sensor for water
Total air system
Total air system (Gamma)

Ending

Small size flow controller

Refrigerating type dryer
Desiccant type dryer
High polymer membrane dryer
Air filter
Auto. drain / others
F.R.L. (Module unit)
F.R.L. (Separate)
Compact F.R.
Precise regulator
F.R.L. (Related products)
Clean F.R.
Electro pneumatic regulator
Air booster
Speed control valve
Silencer
Check valve / others
Joint / tube
Vacuum filter
Vacuum regulator
Suction plate
Magnetic spring buffer
Mechanical pressure SW
Electronic pressure SW
Contact / close contact conf. SW
Air sensor
Pressure SW for coolant
Small flow sensor
Small flow controller
Flow sensor for air
Flow sensor for water
Total air system
Total air system (Gamma)
Ending

Installation & Adjustment

1. Wiring

⚠ DANGER

- Use power voltage and output within the specified voltage. If voltage exceeding the specified voltage is applied, the sensor could malfunction or be damaged, or electrical shock or fire could occur. Do not use a load exceeding the output rating. Failure to observe this could result in output damage or fire.

⚠ WARNING

- Check the connector pin and cable core wire color when wiring. Incorrect connections could result in sensor damage, problems, and malfunctions, so check the wire color against the instruction manual before wiring.
- Check wiring insulation. Check that wires do not contact other circuits, that there is no ground fault, and that the insulator between terminals is not defective. An overload could flow to the product, and result in damage.
- Use a DC stabilized power supply, within the specified rating, insulated from the AC power supply. Failure to insulate the power supply could result in electric shock. If power is not stabilized, the peak could be exceeded during the summer. This could damage this product or cause accuracy to drop.
- Stop controller and devices, and turn power OFF before wiring. Starting operation suddenly could result in unpredictable operation and hazards. Conduct an energized test with controllers and devices stopped, and set target switch data. Discharge any static electricity accumulated by personnel or tools before and during work. Connect and wire bending resistant material, such as robot wire material, for movable sections.
- Do not use this controller at levels exceeding the power voltage range. If voltage exceeding the specified range is applied, or if an AC power (100 VAC) is applied, the controller could break or burn.

- Separate this product and its wiring as far away from sources of noise such as power distribution wires. Provide separate measures for surge applied to the power cable.

- Do not short-circuit the load. This product could break or burn.
- Use stabilized DC power completely separated from the AC primary side for stainless steel construction. Connect either the plus or minus side of the power supply to the FG. A varistor (limit voltage. 40 V) is connected between the stainless steel internal power circuit and stainless steel device to prevent dielectric breakdown of the sensor. Do not conduct a withstand voltage test or insulation resistance test between the internal power circuit and stainless steel device. Disconnect wiring if this testing is required. An excessive potential difference between the power and stainless steel device will cause the internal parts to burn. After installing, connecting, and wiring the stainless steel device, electrical welding of the device or frame or short-circuit accidents, etc., could cause the welding current, the excessive high voltage caused by welding, or a surge voltage, etc., to run through wiring or ground wire connected between the above devices. This could result in damage to wires or devices. Conduct any work such as electrical welding after removing this device and disconnecting all electric wires connected to the FG.

⚠ CAUTION

- The option shield cable connector is a shielded wire. Insulate wires that are not being used so that they do not contact other wires, including shielded wires. If inadvertently connected to the ground, etc., the controller could malfunction or break.
- Check the direction and fit the D-sub connector into the back.
- Lock the D-sub connector so that it does not dislocate. Before loosening the lock, fix the fixing block with a tool, etc.

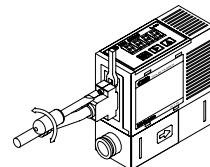

Refrigerating type dryer
Desiccant type dryer
High polymer membrane dryer
Air filter
Auto. drain / others
F.R.L. (Module unit)
F.R.L. (Separate)
Compact F.R.
Precise regulator
F.R.L. (Related products)
Clean F.R.
Electro pneumatic regulator
Air booster
Speed control valve
Silencer
Check valve / others
Joint / tube
Vacuum filter
Vacuum regulator
Suction plate
Magnetic spring buffer
Mechanical pressure SW
Electronic pressure SW
Contact / close contact cont. SW
Air sensor
Pressure SW for coolant
Small flow sensor
Small flow controller
Flow sensor for air
Flow sensor for water
Total air system
Total air system (Gamma)

2. Piping

CAUTION

■ Pipe based on the fluid direction and the direction indicated on the device.

■ Tightening the 4S or 4RM port size (hydrogen, helium model) joint

Tightening the joint

4RM (1/4 inch JXR male joint) ... When gasket material is nickel or SUS316

Tighten the nut by hand until the gasket contacts the bead, then tighten 1/8 of a turn using a tool.

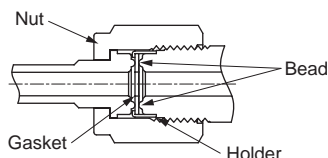

4S (double-barbed joint) ... Confirm that the front ferrule, back ferrule, and nut are correctly attached, and insert tubing until it contacts the back of the main body. Tighten the nut by hand as far as possible, then tighten 1 1/4 of a turn using a tool.

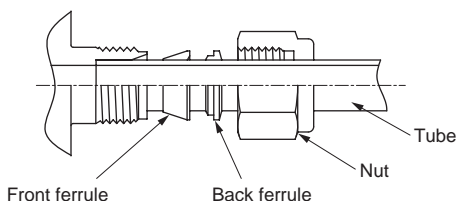

■ Before piping, clean pipes with compressed air to remove any foreign matter of cutting chips, etc. The rectifying unit or platinum sensor could be damaged if foreign matter or cutting chips get in.

■ When attaching piping to this product, use the following torques as reference so that excessive screwing torque or load torque is not applied to the connection port.

Port thread	Tightening torque N·m
Rc1/4	6 to 8
9/16-18UNF	6 to 8

■ When piping, put a wrench, etc., on the stainless steel device so that force is not applied to the resin section.

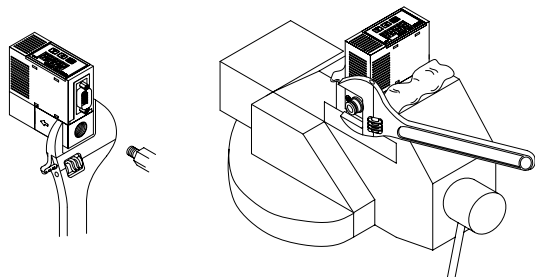

■ Check that sealing tape or adhesive does not get inside when piping.

When winding fluorine resin sealing tape around threads, wind the sealing tape one to two times, leaving two to three threads open at the end of the screw. Press down on the tape to stick it onto threads. When using liquid sealing agent, leave one to two threads open from the end, and avoid applying too much. Check that the sealing agent does not get on the device's threads.

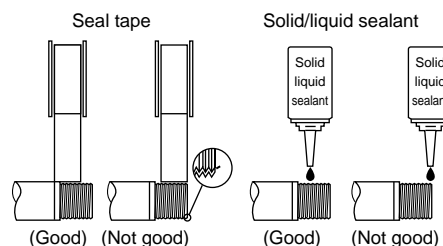

■ Sealant may stick to threads when piping is removed. Be sure to remove sealant before repiping.

■ Connect a joint even when using the stainless steel device with the OUT side opened. The port filter could come off.

■ When using resin construction, do not bend the tube near the push-in joint. If strain could be applied to the tube near the push-in joint, attach an insert ring onto the tube and insert into the push-in joint.

■ When using resin construction, accurately insert the tube and confirm that it does not dislocate even when pulled. Cut the tube at a right angle with a dedicated cutter before using.

■ After piping, confirm that no gas is leaking.

■ When using this product for oxygen gas, monitor the following points.

- Piping work must be completed by personnel with expertise on handling oxygen gas.
- Use oil-treated pipes.
- Remove any dirt or burrs from piping before attaching to this product.
- Attach a filter to the primary side of this product.

Ending

Small size flow controller

During Use & Maintenance

⚠ CAUTION

- Output accuracy is affected by the temperature characteristics and heat self-generated when energized. Provide a standby time (10 minutes or more after turning power ON) when using.
- If a failure occurs during operation, turn power OFF immediately and stop use. Contact your dealer.
- This product does not control the flow for two seconds after power is turned ON so it completes self-diagnosis. Provide a control circuit and program that ignore signals for two seconds after power is turned ON.
- Keep this product's flow within the rated flow range.
- Use this product within the operating differential pressure range.
- When the setting is changed, control devices could operate unintentionally. Stop devices before changing settings.
- Regularly inspect the product at least once a year and confirm that it is operating correctly.
- Do not disassemble or modify this product. Doing so could result in faults.
- This case is made of resin. Do not use solvent, alcohol or any other cleaning agent to remove contamination, etc., or the resin case could be corroded or damaged. Wipe off any dirt with a rag soaked in a diluted neutral detergent solution and wrung out well.
- Monitor leading of the surge current
When controller power is shared with an inductive load that generates a surge, such as a solenoid valve or relay, if the circuit is cut off while the inductive load is functioning, the surge current could enter the output circuit and cause damage depending on where the surge absorption element is installed.

Take the following types of measures to prevent damage from surge current led in.

- (1) Separate the power supply for output comprising the inductive load, such as the solenoid valve and relay, and input, such as the flow controller.
- (2) If separate power supplies cannot be used, directly install a surge absorption element for all inductive loads. Note that the surge absorption element connected to the PLC, etc., protects only that device.
- (3) Connect a surge absorption element to the following on power wiring as shown below as a measure against disconnections in unspecific areas.

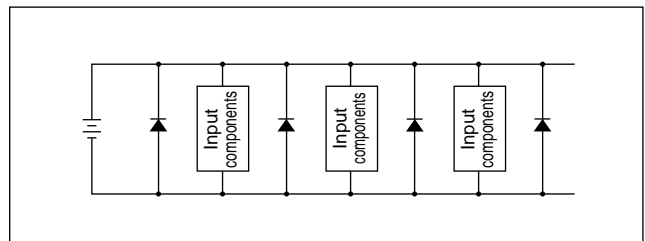

When devices are connected to a connector, the output circuit could be damaged by the above if the connector is disconnected while power is ON. Turn power OFF before connecting or disconnecting the connector.

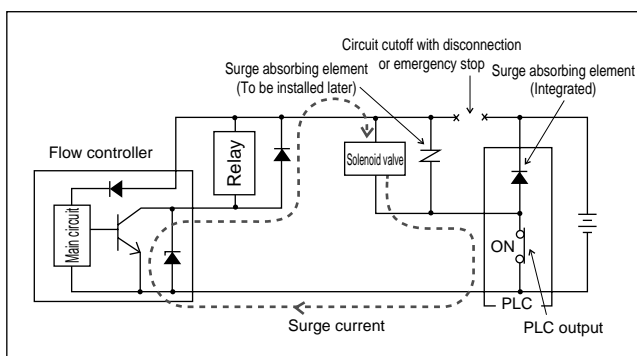

- Refrigerating type dryer
- Desiccant type dryer
- High polymer membrane dryer
- Air filter
- Auto. drain / others
- F.R.L (Module unit)
- F.R.L (Separate)
- Compact F.R.
- Precise regulator
- F.R.L (Related products)
- Clean F.R.
- Electro pneumatic regulator
- Air booster
- Speed control valve
- Silencer
- Check valve / others
- Joint / tube
- Vacuum filter
- Vacuum regulator
- Suction plate
- Magnetic spring buffer
- Mechanical pressure SW
- Electronic pressure SW
- Contact / close contact conf. SW
- Air sensor
- Pressure SW for coolant
- Small flow sensor
- Small flow controller
- Flow sensor for air
- Flow sensor for water
- Total air system
- Total air system (Gamma)
- Ending

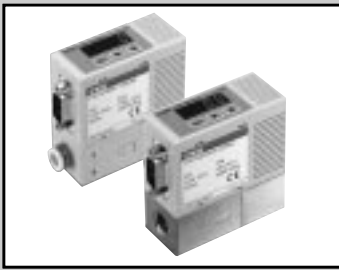

Small size flow controller

FCM Series

- Air, nitrogen, argon, oxygen, city gas, methane, propane (flow rate range: 0.5 to 100 l/min.)
- Hydrogen, helium (flow rate range: 0 to 20 l/min.)



■ FCM Series for air, nitrogen, argon, oxygen, city gas, methane, propane

Specifications

Descriptions		FCM-(*1)(*2)-(*3)(*4)(*5)								
Valve drive method		Proportional solenoid valve			When not energized: Closed					
		Flow range	AI (air, nitrogen)	AR (argon)	O2 (oxygen)	LN (city gas)	C1 (methane)	C3 (propane)		
Full scale flow Note 1	* 1	Standard model	9500	0 to 500m l/min.	●	●	●	●	●	
			0001	0 to 1 l/min.	●	●	●	●	●	
			0002	0 to 2 l/min.	●	●	●	●	●	
			0005	0 to 5 l/min.	●	●	●	●	●	
			0010	0 to 10 l/min.	●	●	●	●	●	
			0020	0 to 20 l/min.	●	●				
			0050	0 to 50 l/min.	●	●				
			0100	0 to 100 l/min. (only resin)	●					
			Low pressure differential model (Only stainless steel)	L9500	0 to 500m l/min.	●		●	●	●
				L0001	0 to 1 l/min.	●		●	●	●
L0002	0 to 2 l/min.	●			●	●	●			
L0005	0 to 5 l/min.	●			●	●	●			
Applicable fluids Note 2	* 2	AI	Compressed air, nitrogen	●						
		AR	Argon		●					
		O2	Oxygen (oil-prohibited specifications)			●				
		LN	City gas (13A) Note 3				●			
		C1	Methane (CH4 100%)					●		
		C3	Propane (C3H8 100%)						●	
Port size/ Body material	* 3	H6	φ 6 push-in, resin (excluding 50, 100 l/min)	●						
		H8	φ 8 push-in, resin	●						
		8A	Rc1/4, stainless steel	●	●	●	●	●		
		UF	9/16-18UNF, stainless steel	●	●	●	●	●		
Control	Control range		3 to 100%F.S.							
	Responsiveness * 1	9500 to 0020, L9500 to L0010	Within 0.5sec. at setting ±5%F.S. (TYP)							
		0050 to 0100	Within 1sec. at setting ±5%F.S. (TYP)							
	Precision		±3%F.S. or less							
	Repeatability		±1%F.S. or less							
	Temperature characteristics		±0.1%F.S./°C or less (25°C reference)							
Pressure characteristics		±1%F.S. or less per 98kPa (standard differential pressure reference)								
Pressure	Standard differential pressure		Note 4 Refer to the separate table							
	Operating differential pressure range		Note 5 Refer to the separate table							
	Withstanding pressure * 3	H6/H8 (resin body)	490kPa							
8A/UF (SUS body)		980kPa								
Ambient temperature / humidity			0 to 50°C, 90%RH or less (no dew)							
I/O	Input signal/ pre-set input	* 4	0	0 to 10 VDC (6.7 Ω) / 4 points (2 bit)						
			1	0 to 5 VDC (10 Ω) / 4 points (2 bit)						
			2	4 to 20 VDC (250 Ω) / 4 points (2 bit)						
			P	Parallel 10bit / None						
	Output signal	* 5	AN	Analog output: 1-5V (connected load impedance 500k Ω and over) Error output: NPN open collector output, 50mA or less, voltage drop 2.4V or less						
			AP	Analog output: 1-5V (connected load impedance 500k Ω and over) Error output: PNP open collector output, 50mA or less, voltage drop 2.4V or less						
			SN	Switch output: NPN open collector output, 50mA or less, voltage drop 2.4V or less Error output: NPN open collector output, 50mA or less, voltage drop 2.4V or less						
			SP	Switch output: PNP open collector output, 50mA or less, voltage drop 2.4V or less Error output: PNP open collector output, 50mA or less, voltage drop 2.4V or less						
Flow display	Display method		3-digit 7-segment LED, Display precision: control precision ±1 digit							
	Display range, display resolution		Refer to the separate table							
Function of integration			Refer to the separate table							
Power supply	Power voltage		24 VDC ±10% (safety power supply with ripple ratio 2% or less)							
	Current consumption		250mA or less							
Installation attitude			Free							
Wet area material	* 3	H6/H8 (resin body)	Polyamide resin, fluoro rubber, stainless steel, alumina, silicone, solder							
		8A/UF (SUS body)	Stainless steel, fluoro rubber, alumina, silicone, solder							
Weight	* 3	H6/H8 (resin body)	Approx. 200g							
		8A/UF (SUS body)	Approx. 480g							
Protective structure			IEC standards IP40							
Protective circuit			Note 6 Power supply reverse connection prevention, switch output reverse connection prevention, switch output load short-circuit protection							
EMC directive			EN55011, EN61000-6-2, EN61000-4-2/3/4/6/8							

Pressure

Standard differential pressure / operating differential pressure Note 4, 5

(Standard model)

			Flow rate range *1							
			9500	0001	0002	0005	0010	0020	0050	0100
Applicable fluids *2	AI	Standard differential pressure (kPa)	50	100	100	100	100	150	200	300
		Operating differential pressure (kPa)	20 to 150	50 to 200	50 to 250	50 to 250	50 to 250	100 to 300	150 to 300	250 to 350
	AR	Standard differential pressure (kPa)	50	100	100	100	100	150	200	
		Operating differential pressure (kPa)	20 to 150	50 to 200	50 to 250	50 to 250	50 to 250	100 to 300	150 to 300	
	O2	Standard differential pressure (kPa)	50	100	100	100	100			
		Operating differential pressure (kPa)	20 to 150	50 to 200	50 to 250	50 to 250	50 to 250			
	LN/C1	Standard differential pressure (kPa)	50	50	50	50	50			
		Operating differential pressure (kPa)	20 to 150	20 to 150	20 to 150	20 to 150	30 to 150			
	C3	Standard differential pressure (kPa)	50	50	50	50	50			
		Operating differential pressure (kPa)	20 to 150	20 to 150	20 to 150	20 to 150	30 to 150			

(Low pressure differential model)

			Flow rate range *1				
			L9500	L0001	L0002	L0005	L0010
Applicable fluids *2	AI/O2	Standard differential pressure (kPa)	20	20	20	20	20
	LN/C1						
	C3	Operating differential pressure (kPa)	5 to 50	5 to 50	5 to 50	5 to 50	10 to 50

Display/integration

			Flow rate range *1							
			9500 L9500	0001 L0001	0002 L0002	0005 L0005	0010 L0010	0020	0050	0100
Flow display	Display range		0 to 500m ℓ/min.	0.00 to 1.00 ℓ/min.	0.00 to 2.00 ℓ/min.	0.00 to 5.00 ℓ/min.	0.0 to 10.0 ℓ/min.	0.0 to 20.0 ℓ/min.	0.0 to 50.0 ℓ/min.	0 to 100 ℓ/min.
	Display resolution		1mℓ/min	0.01ℓ/min	0.01ℓ/min	0.01ℓ/min	0.1ℓ/min	0.1ℓ/min	0.1ℓ/min	1ℓ/min
Function of integration	Display range		999999m ℓ	9999.99 ℓ	9999.99 ℓ	9999.99 ℓ	99999.9 ℓ	99999.9 ℓ	99999.9 ℓ	999999 ℓ
	Display resolution		1mℓ	0.01ℓ	0.01ℓ	0.01ℓ	0.1ℓ	0.1ℓ	0.1ℓ	1ℓ
	Pulse output rate		5mℓ	0.01ℓ	0.02ℓ	0.05ℓ	0.1ℓ	0.2ℓ	0.5ℓ	1ℓ

Note 1: Converted to volumetric flow at 20°C 1 barometric pressure (101kPa)

Note 2: When using compressed air, use clean air that complies to JIS B 8392-1:2003 Class 1.1.1 to 1.6.2. Compressed air from the compressor contains drainage (water, oxidized oil, foreign matter, etc.). Install a filter (filtration: 5 μm), air dryer (minimum pressure dew point: 10 °C or less), and oil mist filter (maximum oil concentration: 0.1 mg/m³) on the primary side of this product to maintain product functions.

<Recommended circuit>

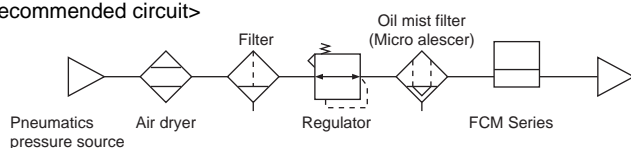

<Recommended component>

Air filter: F Series

Oil mist filter: M Series

When using for other than compressed air, use dry gas that does not contain corrosive elements such as chlorine, sulfur, or acids, and clean gas that does not contain dust or oil mist.

Note 3: City gas 13 A is for methane (CH₄) 88% gas generated from LNG.

Note 4: The standard differential pressure is the differential pressure when this product is calibrated.

Note 5: The operating differential pressure is the differential pressure required to operate this product normally. Contact CKD when using this product at a level exceeding the operating differential pressure.

Note 6: This product's protective circuit is effective only for specific incorrect connections and load short-circuits. It does not necessarily provide protection for all incorrect connections.

Refrigerating type dryer
Desiccant type dryer
High polymer membrane dryer
Air filter
Auto. drain / others
F.R.L. (Module unit)
F.R.L. (Separate)
Compact F.R.
Precise regulator
F.R.L. (Related products)
Clean F.R.
Electro pneumatic regulator
Air booster
Speed control valve
Silencer
Check valve / others
Joint / tube
Vacuum filter
Vacuum regulator
Suction plate
Magnetic spring buffer
Mechanical pressure SW
Electronic pressure SW
Contact / close contact cont. SW
Air sensor
Pressure SW for coolant
Small flow sensor
Small flow controller
Flow sensor for air
Flow sensor for water
Total air system
Total air system (Gamma)

Ending

Small size flow controller

FCM Series for hydrogen, helium

Specifications

Descriptions		FCM- (*1) (*2) - (*3) (*4) (*5)				
Valve drive method		Proportional solenoid valve When not energized: Closed				
		Flow range		H2 (hydrogen)	HE (helium)	
Full scale flow Note 1	* 1	0002	0 to 2 ℓ/min.	●	●	
		0005	0 to 5 ℓ/min.	●	●	
		0010	0 to 10 ℓ/min.	●	●	
		0020	0 to 20 ℓ/min.	●	●	
Applicable fluids		* 2	H2 Hydrogen	●	●	
			HE Helium		●	
Port size		* 3	8A Rc1/4	●	●	
			UF 9/16-18UNF	●	●	
			4S 1/4 inch double barbed joint	●	●	
			4RM 1/4 inch JXR male joint	●	●	
Control		Control range		3 to 100%F.S.		
		Responsiveness		* 1 Within 0.5sec. at setting ±5%F.S. (TYP)		
		Precision		±3%F.S. or less		
		Repeatability		±1%F.S. or less		
		Temperature characteristics		±0.2%F.S./°C or less (25°C reference)		
		Pressure characteristics		±1%F.S. or less per 98kPa (standard differential pressure reference)		
Pressure		Standard differential pressure		Note 2	Refer to the separate table	
		Operating differential pressure range		Note 3	Refer to the separate table	
		Withstanding pressure		980kPa		
Ambient temperature / humidity		0 to 50°C, 90%RH or less (no dew)				
External leakage		1 x 10 ⁻⁶ Pa/m ³ /s or less (helium leak rate)				
I/O	Input signal/ pre-set input	* 4	0	0 to 10 VDC (6.7 Ω) / 4 points (2 bit)		
			1	0 to 5 VDC (10 Ω) / 4 points (2 bit)		
			2	4 to 20 VDC (250 Ω) / 4 points (2 bit)		
			P	Parallel 10bit / None		
	Output signal	* 5	AN	Analog output: 1-5V (connected load impedance 500kΩ and over) Error output: NPN open collector output, 50mA or less, voltage drop 2.4V or less		
			AP	Analog output: 1-5V (connected load impedance 500kΩ and over) Error output: PNP open collector output, 50mA or less, voltage drop 2.4V or less		
			SN	Switch output: NPN open collector output, 50mA or less, voltage drop 2.4V or less Error output: PNP open collector output, 50mA or less, voltage drop 2.4V or less		
			SP	Switch output: PNP open collector output, 50mA or less, voltage drop 2.4V or less Error output: PNP open collector output, 50mA or less, voltage drop 2.4V or less		
Flow display	Display method		3-digit 7-segment LED, display system: control precision ±1 digit			
	Display range, display resolution		Refer to the separate table			
Function of integration		Refer to the separate table				
Power supply	Power voltage		24 VDC ±10% (safety power supply with ripple ratio 1% or less)			
	Current consumption		270mA or less			
Installation attitude		Free				
Wet area material		Stainless steel, fluoro rubber, alumina, silicone, solder				
Weight	* 3	8A/UF	Approx. 480g			
		4S/4RM	Approx. 560g			
Protective structure		IEC standards IP40				
Protective circuit		Note 4	Power supply reverse connection prevention, switch output reverse connection prevention, switch output load short-circuit protection			
EMC directive		EN55011, EN61000-6-2, EN61000-4-2/3/4/6/8				

Pressure

Standard differential pressure / operating differential pressure

			Flow rate range *1			
			0002	0005	0010	0020
Applicable fluids *2	H2	Standard differential pressure (kPa)	20	50	50	50
		Operating differential pressure (kPa)	10 to 50	30 to 80	30 to 80	30 to 80
	HE	Standard differential pressure (kPa)	50	100	100	100
		Operating differential pressure (kPa)	20 to 100	50 to 150	50 to 150	50 to 150

Display/integration

			Flow rate range *1			
			0002	0005	0010	0020
Flow display	Display range		0.00 to 2.00 ℓ /min.	0.00 to 5.00 ℓ /min.	0.0 to 10.0 ℓ/min.	0.0 to 20.0 ℓ/min.
	Display resolution		0.01 ℓ/min	0.01 ℓ/min	0.1 ℓ/min	0.1 ℓ/min
Function of integration	Display range		9999.99 ℓ	9999.99 ℓ	99999.9 ℓ	99999.9 ℓ
	Display resolution		0.01 ℓ	0.01 ℓ	0.1 ℓ	0.1 ℓ
	Pulse output rate		0.02 ℓ	0.05 ℓ	0.1 ℓ	0.2 ℓ

Note 1: Converted to volumetric flow at 20°C 1 barometric pressure (101kPa)

Note 2: The standard differential pressure is the differential pressure when this product is calibrated.

Note 3: The operating differential pressure is the differential pressure required to operate this product normally.

Note 4: This product's protection circuit is effective only for specific misconnections and load short-circuits. It does not provide protection for all misconnections.

Refrigerating type dryer
Desiccant type dryer
High polymer membrane dryer
Air filter
Auto. drain / others
F.R.L. (Module unit)
F.R.L. (Separate)
Compact F.R.
Precise regulator
F.R.L. (Related products)
Clean F.R.
Electro pneumatic regulator
Air booster
Speed control valve
Silencer
Check valve / others
Joint / tube
Vacuum filter
Vacuum regulator
Suction plate
Magnetic spring buffer
Mechanical pressure SW
Electronic pressure SW
Contact / close contact cont. SW
Air sensor
Pressure SW for coolant
Small flow sensor
Small flow controller
Flow sensor for air
Flow sensor for water
Total air system
Total air system (Gamma)

Ending

Small size flow controller

FCM Series for air, nitrogen, argon, oxygen, city gas, methane, propane

How to order

FCM - 9500 AI - H6 0 AN R 1 B T

Model no.

Traceability

Bracket

A Flow rate range

B Working fluid

C Port, body material

D Input specifications

E Output specifications

F Display direction

G Cable

Symbol	Descriptions							
A Flow rate range								
		Working fluid						
		AI	AR	O2	LN	C1	C3	
9500	Standard model	0 to 0.5 l/min.	●	●	●	●	●	
0001		0 to 1 l/min.	●	●	●	●	●	
0002		0 to 2 l/min.	●	●	●	●	●	
0005		0 to 5 l/min.	●	●	●	●	●	
0010		0 to 10 l/min.	●	●	●	●	●	
0020		0 to 20 l/min.	●	●				
0050		0 to 50 l/min.	●	●				
0100		0 to 100 l/min. (only resin body)	●					
L9500		Low pressure differential mode (Only stainless steel)	0 to 0.5 l/min.	●		●	●	●
L0001			0 to 1 l/min.	●		●	●	●
L0002	0 to 2 l/min.		●		●	●	●	
L0005	0 to 5 l/min.		●		●	●	●	
L0010	0 to 10 l/min.		●		●	●	●	

B Working fluid	
AI	Compressed air, nitrogen gas
AR	Argon
O2	Oxygen (oil-prohibited specifications)
LN	City gas (13A)
C1	Methane (CH ₄)
C3	Propane (C ₃ H ₈)

C Port, body material						
Working fluid						
	AI AR O2 LN C1 C3					
H6	Push-in (φ6), resin body (Excluding flow rate range: 0050, 0100)	●				
H8	Push-in (φ8), resin body	●				
8A	Rc1/4, stainless steel body	●	●	●	●	●
UF Note 1	9/16-18 UNF, stainless steel body	●	●	●	●	●

D Input specifications	
0	Analog 0-10 VDC
1	Analog 0-5 VDC
2	Analog 4-20mADC
P	Parallel 10bit

E Output specifications	
AN	1-5V analog error (NPN)
AP	1-5V analog error (PNP)
SN	Switch (NPN), error (NPN)
SP	Switch (PNP), error (PNP)

F Display direction	
Blank	Positive direction
R	Reverse direction

G Cable	
Blank	None
1	1m
3	3m

H Bracket	
Blank	None
B	With bracket

I Traceability	
Blank	None
T	Traceability Certificate, system diagram, inspection results included
K	Inspection results included

<Example of model number>

FCM-0001AI-H81ANR1BK

Model: Small size flow controller FCM

- A** Flow rate range : 0 to 1 l/min.
- B** Working fluid : Compressed air, nitrogen
- C** Port/body material : Push-in (φ8), resin body
- D** Input specifications : Analog 0-5 VDC
- E** Output specifications : 1-5V analog, error (NPN)
- F** Display direction : Reverse direction
- G** Cable : 1m
- H** Bracket : With bracket
- I** Traceability : With inspection results

⚠ Note on model no. selection

Note 1: Refer to the dimensions on page 1348 for the 9/16-18UNF screw shape.

Discrete option model no.

FCM - AC1

Symbol	Descriptions
AC1	Analog 9-conductor, cable 1 m
AC3	Analog 9-conductor, cable 3 m
PC1	Parallel 15-conductor, cable 1 m
PC3	Parallel 15-conductor, cable 3 m
LB1	Bracket

■ For hydrogen, helium

How to order

FCM - **0002** **H2** - **8A** **0** **AN** **R** **1** **B** **T**

Model no.

① Traceability
⑧ Bracket

Ⓐ Flow rate range

Ⓑ Working fluid

Ⓒ Port

Ⓓ Input specifications

Ⓔ Output specifications

Ⓕ Display direction

Ⓖ Cable

Symbol	Descriptions		
Ⓐ Flow rate range			
Working fluid		H2	HE
0002	0 to 2 ℓ/min.	●	●
0005	0 to 5 ℓ/min.	●	●
0010	0 to 10 ℓ/min.	●	●
0020	0 to 20 ℓ/min.	●	●
Ⓑ Working fluid			
H2	Hydrogen		
HE	Helium		
Ⓒ Port			
Working fluid		H2	HE
8A	Rc1/4	●	●
UF	9/16-18UNF	●	●
4S	1/4 inch double barbed joint	●	●
4RM	1/4 inch JXR male joint	●	●
Ⓓ Input specifications			
0	Analog 0-10 VDC		
1	Analog 0-5 VDC		
2	Analog 4-20mADC		
P	Parallel 10bit		
Ⓔ Output specifications			
AN	1-5V analog error (NPN)		
AP	1-5V analog error (PNP)		
SN	Switch (NPN), error (NPN)		
SP	Switch (PNP), error (PNP)		
Ⓕ Display direction			
Blank	Positive direction		
R	Reverse direction		
Ⓖ Cable			
Blank	None		
1	1m		
3	3m		
Ⓖ Bracket			
Blank	None		
B	With bracket		
① Traceability			
Blank	None		
T	Traceability Certificate, system diagram, inspection results included		
K	Inspection results included		

<Example of model number>

FCM-0002H2-8A1ANR1BK

- Ⓐ Flow rate range : 0 to 2 ℓ/min.
- Ⓑ Working fluid : Hydrogen
- Ⓒ Port : Rc1/4
- Ⓓ Input specifications : Analog 0-5 VDC
- Ⓔ Output specifications : 1-5V analog, error (NPN)
- Ⓕ Display direction : Reverse direction
- Ⓖ Cable : 1m
- Ⓖ Bracket : With bracket
- ① Traceability : With inspection results

Discrete option model no.

FCM - **AC1**

Symbol	Descriptions
AC1	Analog 9-conductor, cable 1 m
AC3	Analog 9-conductor, cable 3 m
PC1	Parallel 15-conductor, cable 1 m
PC3	Parallel 15-conductor, cable 3 m
LB1	Bracket

Refrigerating type dryer
Desiccant type dryer
High polymer membrane dryer
Air filter
Auto. drain / others
F.R.L. (Module unit)
F.R.L. (Separate)
Compact F.R.
Precise regulator
F.R.L. (Related products)
Clean F.R.
Electro pneumatic regulator
Air booster
Speed control valve
Silencer
Check valve / others
Joint / tube
Vacuum filter
Vacuum regulator
Suction plate
Magnetic spring buffer
Mechanical pressure SW
Electronic pressure SW
Contact / close contact cont. SW
Air sensor
Pressure SW for coolant
Small flow sensor
Small flow controller
Flow sensor for air
Flow sensor for water
Total air system
Total air system (Gamma)

Ending

Small size flow controller

Dimensions

Refrigerating type dryer
Desiccant type dryer
High polymer membrane dryer
Air filter
Auto. drain / others
F.R.L (Module unit)
F.R.L (Separate)
Compact F.R.
Precise regulator
F.R.L (Related products)
Clean F.R.
Electro pneumatic regulator
Air booster
Speed control valve
Silencer
Check valve / others
Joint / tube
Vacuum filter
Vacuum regulator
Suction plate
Magnetic spring buffer
Mechanical pressure SW
Electronic pressure SW
Contact / close contact conf. SW
Air sensor
Pressure SW for coolant
Small flow sensor
Small flow controller
Flow sensor for air
Flow sensor for water
Total air system
Total air system (Gamma)
Ending

Body material: Resin, port size: 6, 8

● FCM-*-H8/H6*

The display direction is reverse for the FCM-*-R*.

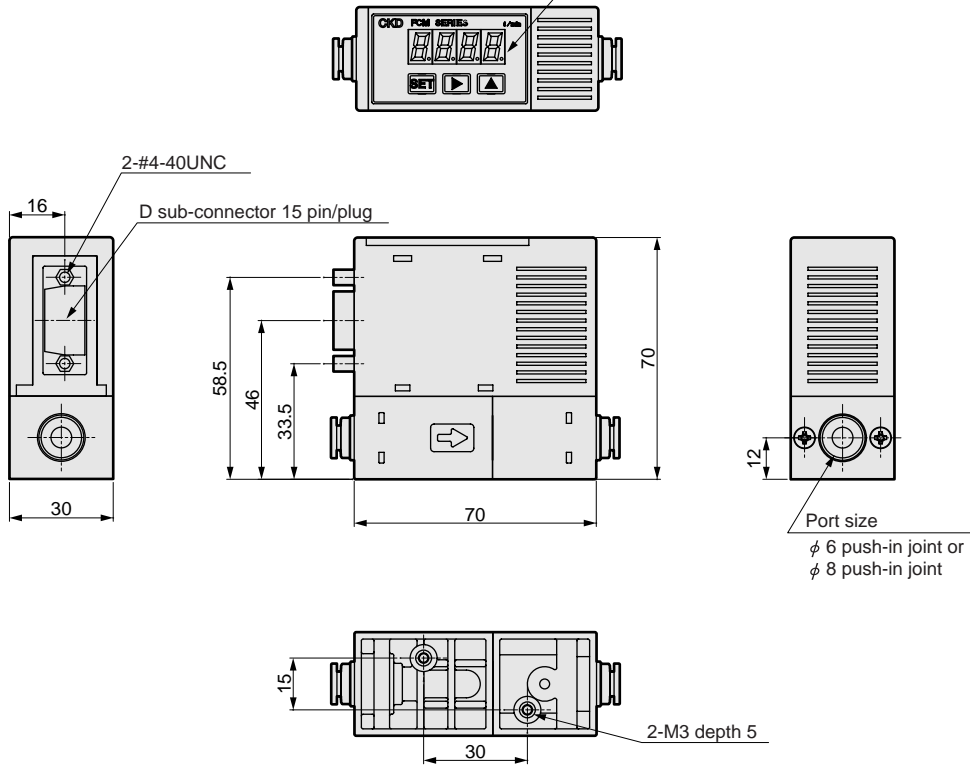

Body material: Stainless steel, port size: Rc1/4, 9/16-18UNF

● FCM-*-8A/UF

The display direction is reverse for the FCM-*-R*.

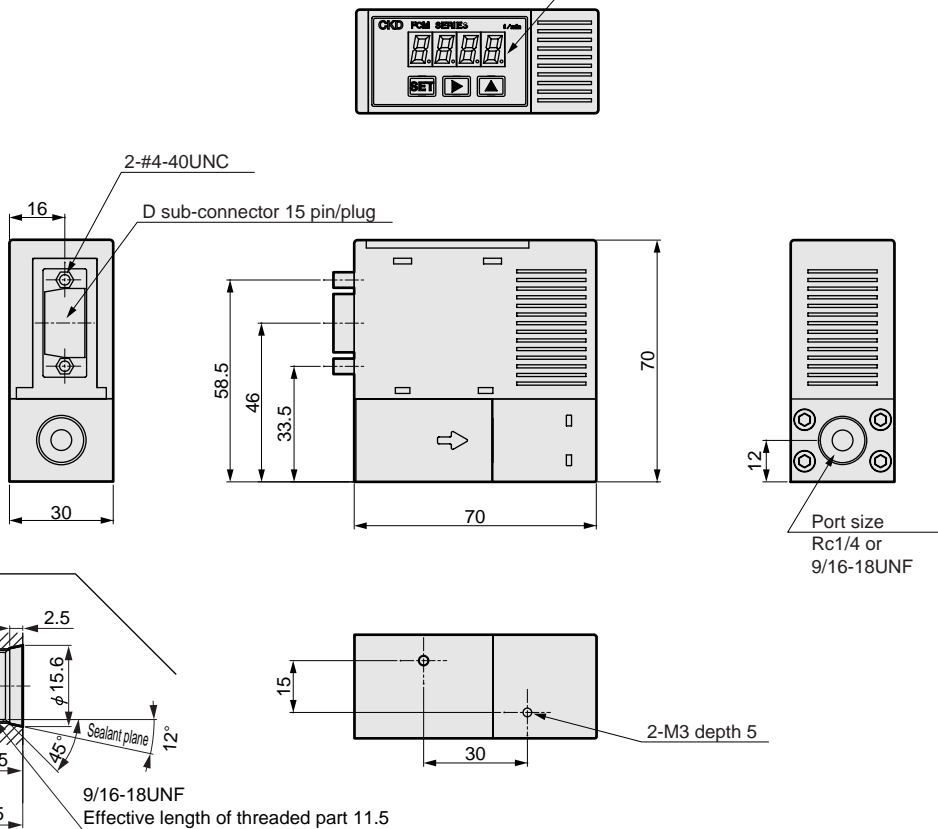

Dimensions

Port size: 1/4 inch double barbed joint

● FCM-*-4S

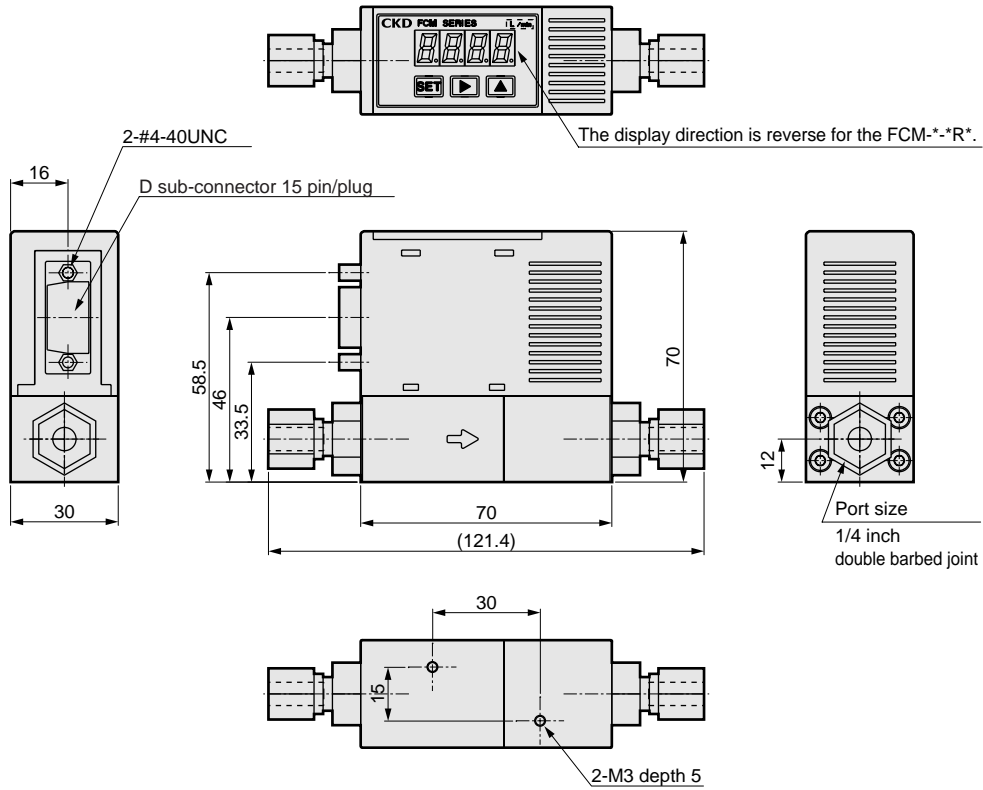

Port size: 1/4 inch JXR male joint

● FCM-*-4RM

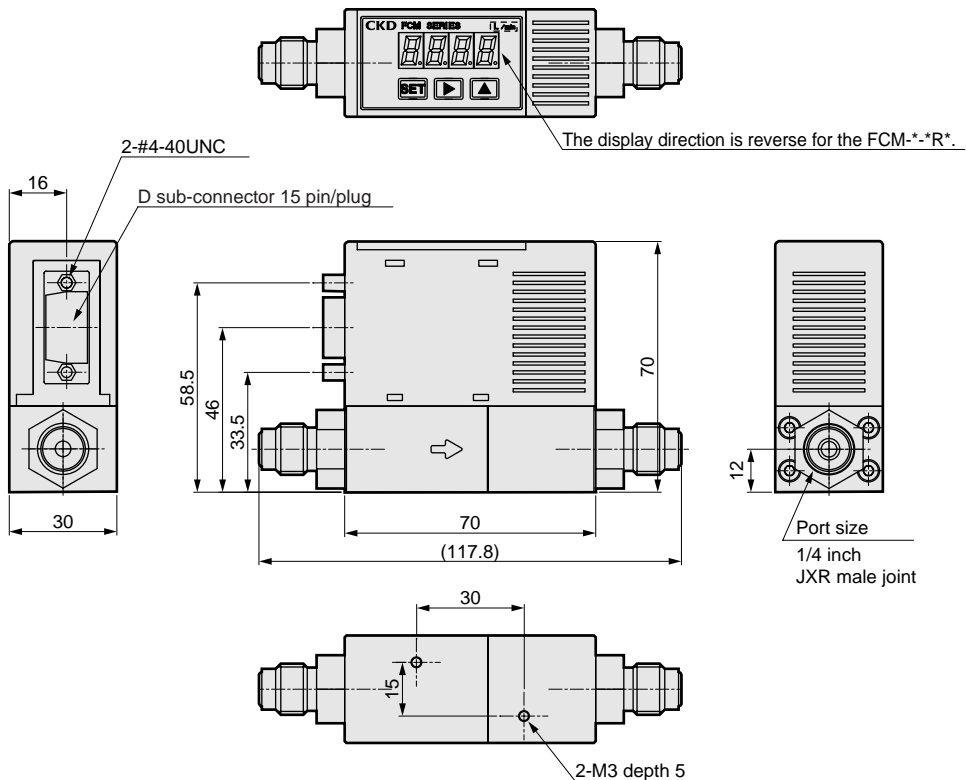

Refrigerating type dryer
Desiccant type dryer
High polymer membrane dryer
Air filter
Auto. drain / others
F.R.L. (Module unit)
F.R.L. (Separate)
Compact F.R.
Precise regulator
F.R.L. (Related products)
Clean F.R.
Electro pneumatic regulator
Air booster
Speed control valve
Silencer
Check valve / others
Joint / tube
Vacuum filter
Vacuum regulator
Suction plate
Magnetic spring buffer
Mechanical pressure SW
Electronic pressure SW
Contact / close contact cont. SW
Air sensor
Pressure SW for coolant
Small flow sensor
Small flow controller
Flow sensor for air
Flow sensor for water
Total air system
Total air system (Gamma)

Ending

Small size flow controller

Bracket (floor installation type)

Discrete model no.: FCM-LB1

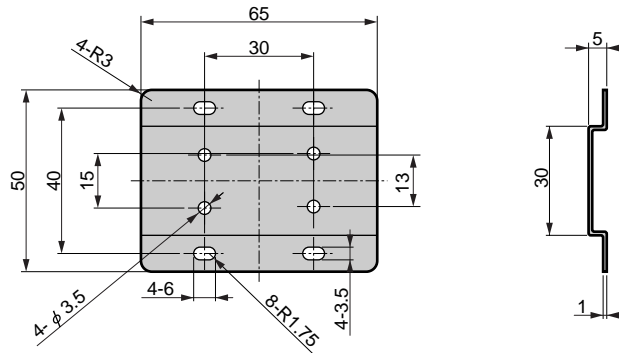

Cable optional dimensions

● 9-conductor cable for analog input type

Discrete option model no.: FCM-AC1, AC3

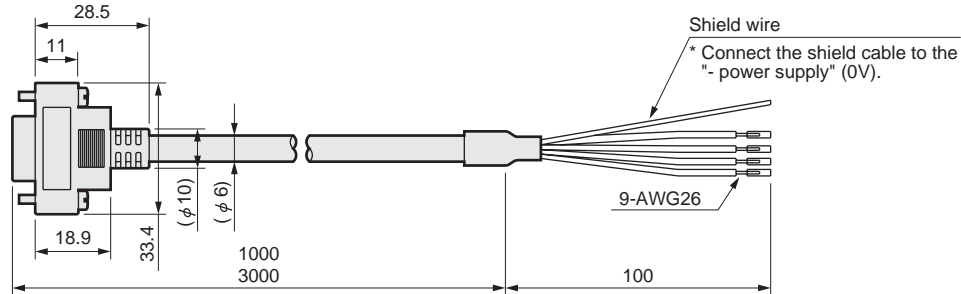

D-sub socket pin No.	1	2	3	4	5	6	7	8	9	10	11	12	13	14	15		
Isolator color	Brown	Orange	Yellow	-	Red	-	-	-	-	Gray	White	-	Green	Blue	Black		
Name	Pre-set input signal		Integration reset signal	Vacant	Power supply + +24VDC	Vacant	Vacant	Vacant	Vacant	Common	Input signal		Vacant	Analog output 1-5VDC	Switch output NPN or PNP output	Error output NPN or PNP output	Power supply- (0V)
Type of input	Bit 1	Bit 2									0-10 VDC	0-5 VDC					

Note: The No. 1 pin common is common for the preset input and integration reset signal (No. 1 to 3 pins).

● 15-conductor cable for parallel input type

Discrete option model no.: FCM-PC1, PC3

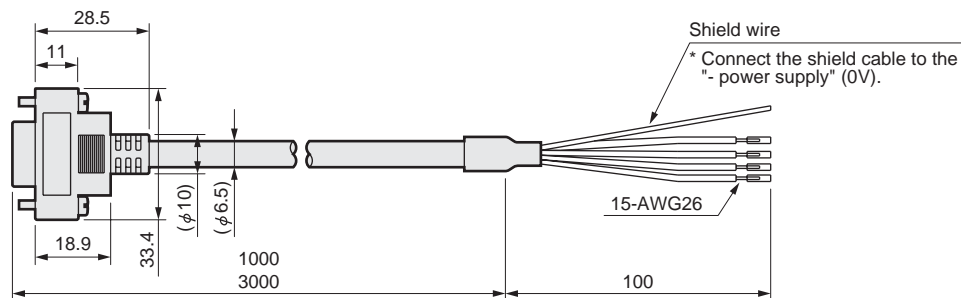

D-sub socket pin No.	1	2	3	4	5	6	7	8	9	10	11	12	13	14	15	
Isolator color	Brown	Orange	Yellow	Purple	Red	Light blue	Pink	White (with black line)	Red (with black line)	Gray	White	Green (with black line)	Green	Blue	Black	
Name	Parallel input signal				Power supply + +24VDC	Parallel input signal				Common	Parallel input signal		Analog output 1-5VDC	Switch output NPN or PNP output	Error output NPN or PNP output	Power supply- (0V)
Type of input	Bit 1	Bit 2	Bit 3	Bit 4		Bit 5	Bit 6	Bit 7	Bit 8		Bit 9	Bit 10				

Note: The No. 10 pin common is common for the parallel input signals (No. 1 to 4, 6 to 9, 11, 12 pins).

Wiring methods

Examples of internal circuit and load connection Parallel input type

⚠ Caution: Care must be taken for incorrect wiring.

FCM-*-*0/1/2 AN*
(Analog input, analog output + error output type NPN output)

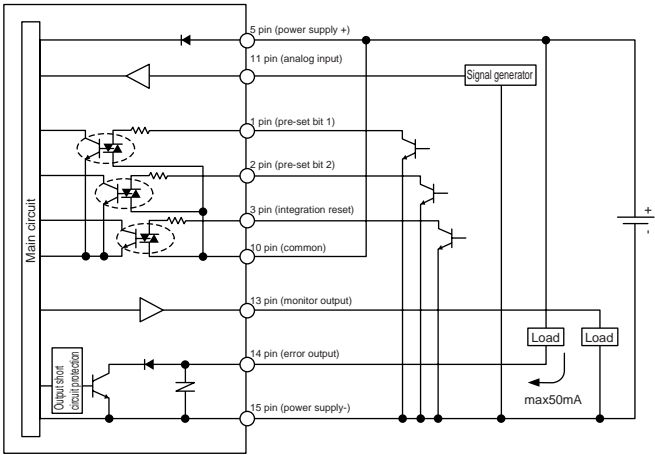

FCM-*-*0/1/2 AP*
(Analog input, analog output + error output type PNP output)

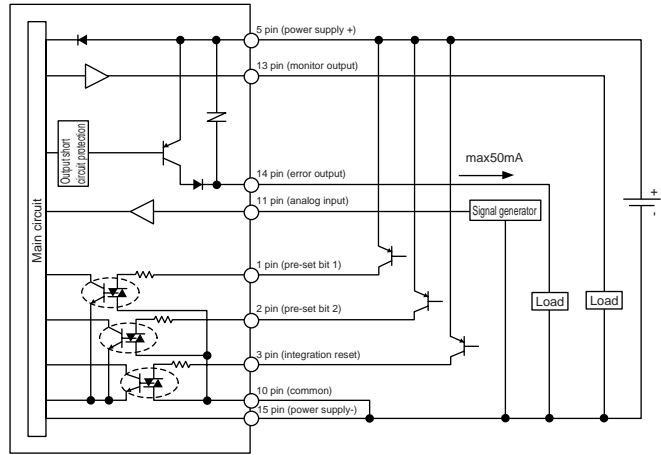

FCM-*-*0/1/2 SN*
(Analog input, switch output + error output type NPN output)

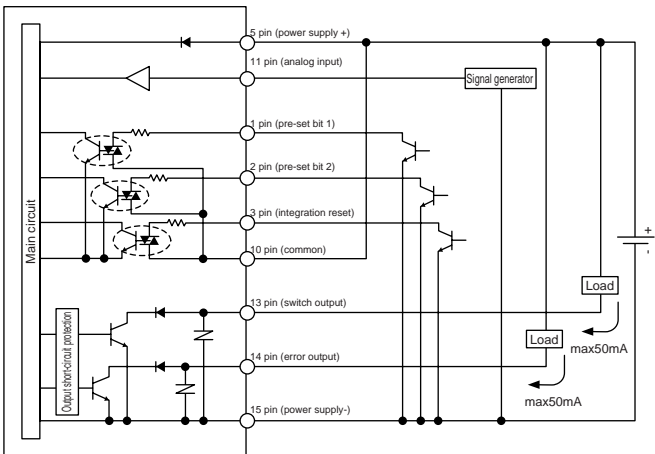

FCM-*-*0/1/2 SP*
(Analog input, switch output + error output type PNP output)

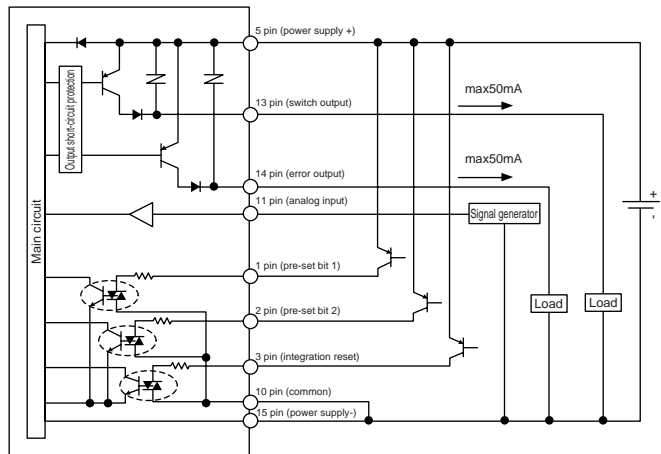

■ Connector pin arrangement (product side)
(Analog input type)

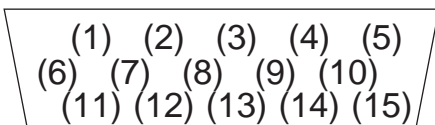

The analog input type does not have the
(4), (6), (7), (8), (9) or (12) pins.

Refrigerating type dryer
Desiccant type dryer
High polymer membrane dryer
Air filter
Auto. drain / others
F.R.L. (Module unit)
F.R.L. (Separate)
Compact F.R.
Precise regulator
F.R.L. (Related products)
Clean F.R.
Electro pneumatic regulator
Air booster
Speed control valve
Silencer
Check valve / others
Joint / tube
Vacuum filter
Vacuum regulator
Suction plate
Magnetic spring buffer
Mechanical pressure SW
Electronic pressure SW
Contact / close contact cont. SW
Air sensor
Pressure SW for coolant
Small flow sensor
Small flow controller
Flow sensor for air
Flow sensor for water
Total air system
Total air system (Gamma)
Ending

Small size flow controller

Examples of internal circuit and load connection Parallel input type

⚠ Caution: Care must be taken for incorrect wiring.

FCM-*-*PAN*
(Parallel input, analog output + error output type NPN output)

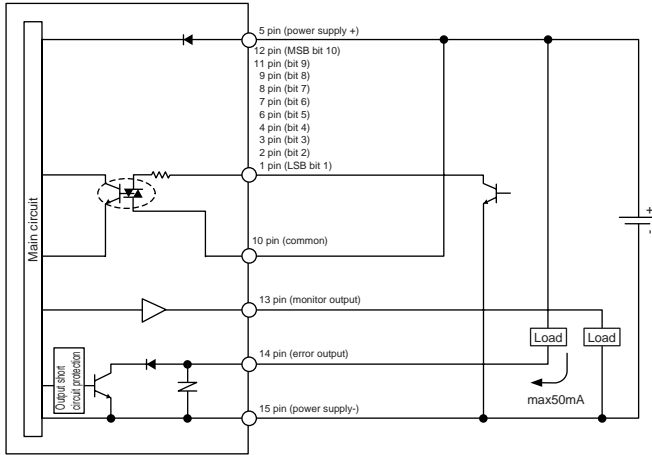

FCM-*-*PAP*
(Parallel input, analog output + error output type PNP output)

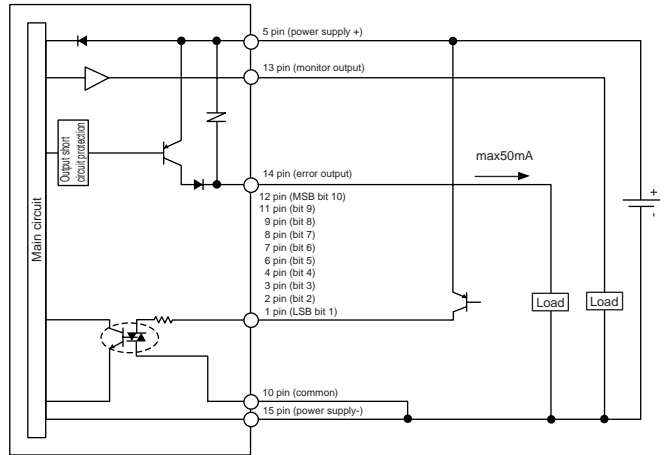

FCM-*-*PSN*
(Parallel input, switch output + error output type NPN output)

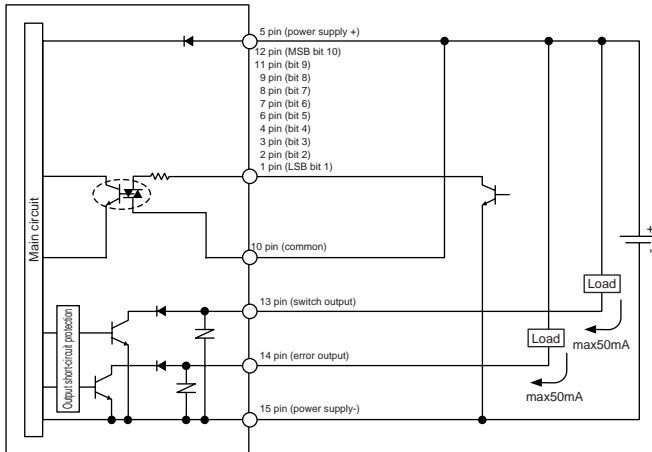

FCM-*-*PSP*
(Parallel input, switch output + error output type PNP output)

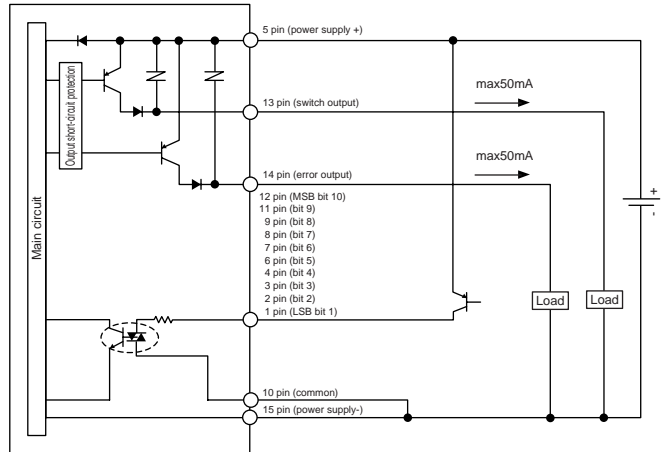

■ Connector pin arrangement (product side)
(Parallel input type)

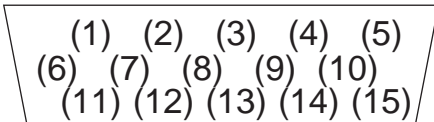

- Refrigerating type dryer
- Desiccant type dryer
- High polymer membrane dryer
- Air filter
- Auto. drain / others
- F.R.L (Module unit)
- F.R.L (Separate)
- Compact F.R.
- Precise regulator
- F.R.L (Related products)
- Clean F.R.
- Electro pneumatic regulator
- Air booster
- Speed control valve
- Silencer
- Check valve / others
- Joint / tube
- Vacuum filter
- Vacuum regulator
- Suction plate
- Magnetic spring buffer
- Mechanical pressure SW
- Electronic pressure SW
- Contact / close contact conf. SW
- Air sensor
- Pressure SW for coolant
- Small flow sensor
- Small flow controller
- Flow sensor for air
- Flow sensor for water
- Total air system
- Total air system (Gamma)
- Ending

Small size flow controller FCM Series function

Functional explanation

Function	Descriptions	Compatible models				Operation
		Analog input		Parallel input		
		Analog output	Switch output	Analog output	Switch output	
Direct memory function	The target is input with keys. Even if input signals from an external source are not used, control flow rate is freely adjusted with controller operation keys.	○	○	○	○	P1355, 1356 P1366
Pre-set input function	When four random flow rate points are set, the flow rate is controlled by inputting a 2-bit signal from an external source (signals from PLC, etc.).	○	○			P1357 P1366
Analog input function	The flow can be controlled with an analog input signal.	○	○			P1359 P1366
Parallel input function	The flow rate is controlled with a parallel 10-bit (signal from PLC, etc.) Expensive input/output devices, such as a D/A converter, are not required.			○	○	P1360 P1366
Function of integration	The flow is integrated. The following functions are used in addition to the integrated flow display. <ul style="list-style-type: none"> The solenoid valve is closed and stopped at the set integrated flow. Integrating pulse function (only switch output) Switch ON at set integrated flow (only switch output) How to reset integration <ul style="list-style-type: none"> Analog input type: External input, button operation Parallel input type: Only button operation 	○ No integrating pulse switch	○	○ No integrating pulse switch	○	P1361 P1362 P1365 P1367 P1368
Switch output	The following switch can be selected. <ul style="list-style-type: none"> (1) Tolerance mode: The switch turns ON when the level is within the tolerance (randomly set) of control target. (2) Range designation mode: The switch turns ON when the level is not within the designated flow rate range. (3) Integrating pulse: The integrated pulse is output during integration. (4) ON when higher than set integration: The switch turns ON at the set integrated flow. <p>(Mode 1: Tolerance mode) (Mode 2: Range designation mode)</p> <p>H (+ tolerance) Input signal set value L (-tolerance)</p> <p>H (upper limit side) L (lower limit side)</p> <p>Output ON OFF</p> <p>(Mode 3: Integrating pulse) (Mode 4: ON when set integration value and over)</p> <p>Approx. 50msec</p> <p>ON OFF</p> <p>Refer to pages 1343 to 1345 for pulse output rate. Set integration</p>		○		○	P1362 P1363 P1364 P1367
Input signal zero/span adjustment function	The input signal's zero point and span point is changed. 	○	○			P1367
Zero point adjustment	The flow output zero point is adjusted.	○	○	○	○	P1368
Automatic power off	The flow rate display turns OFF if there are no operations for one minute. (Control does not stop when the auto power OFF function activates.)	○	○	○	○	P1367
Error display function	The error state is displayed. The following functions are used for the error display. <ul style="list-style-type: none"> Error output is turned ON if an error occurs Control stops automatically an error occurs 	○	○	○	○	P1354 P1368
Error automatic shutoff	If an error occurs, control is stopped, the valve is fully opened, and error output is turned ON.	○	○	○	○	P1368
Key lock	Setting changes are disabled to prevent incorrect operations.	○	○	○	○	P1365
Setting reset	Settings are returned to defaults. (Only input signal selection, switch output, input signal zero/span adjustment or auto power off)	○	○	○	○	P1365

Refrigerating type dryer
 Desiccant type dryer
 High polymer membrane dryer
 Air filter
 Auto. drain / others
 F.R.L. (Module unit)
 F.R.L. (Separate)
 Compact F.R.
 Precise regulator
 F.R.L. (Related products)
 Clean F.R.
 Electro pneumatic regulator
 Air booster
 Speed control valve
 Silencer
 Check valve / others
 Joint / tube
 Vacuum filter
 Vacuum regulator
 Suction plate
 Magnetic spring buffer
 Mechanical pressure SW
 Electronic pressure SW
 Contact / close contact cont. SW
 Air sensor
 Pressure SW for coolant
 Small flow sensor
 Small flow controller
 Flow sensor for air
 Flow sensor for water
 Total air system
 Total air system (Gamma)

Small size flow controller

Names and functions of display and operation section

Output display (red)

- "F" is displayed while confirming function settings.
 - "-" is displayed when switch output is ON. (Only switch output)
 - * The display blinks when overcurrent is detected.
 - * The display does not blink with integrated pulse output.
 - "E" is displayed when error output is ON.
 - * The display blinks when overcurrent is detected.
- * If an upper/lower limit applies when setting the function, or when displaying both the high-order digit and low-order digit of the integrated flow display, **H** or **L** is displayed.

3-digit LED display (green)

- The instantaneous flow rate display and function setting details are displayed in the RUN mode (instantaneous flow rate display).
 - * The setting mode No. and setting details are displayed when displaying details of function settings.
 - Values, etc., are displayed when setting each data.
 - The error code No. is displayed when the error is displayed.
-

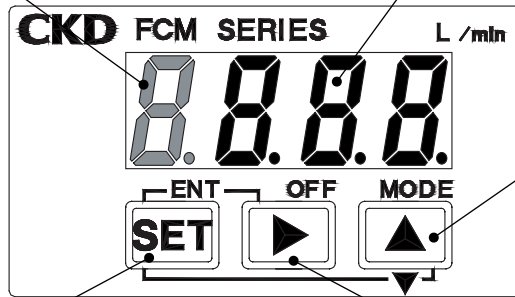

- #### ▲ UP key (MODE key)
- Press to count up the value, etc.
 - Press to change the setting mode.
 - Press to change the setting item.

- #### ■ SET Key
- Press to set the setting mode.
 - Press to set the setting item.
 - Press to change to the display of integration.

- #### ▶ Shift key (OFF key)
- Press to select the digit for a number, etc.
 - Press to restore operation from the forced OFF state, when forced OFF (control stop) is executed.

- #### ■ SET + ▶ Key (ENT key)
- Press to set the value.
 - Press to unlock the key lock.
 - Press to execute integration reset.

- #### ■ SET + ▲ Key (DOWN key)
- Press to count down the value, etc.
 - Press to lock keys.

- #### ▶ + ▲ Key
- Press to initialize values.

Error code table

Error display	Cause	Countermeasures	Errors subject to error automatic shutoff (Note 1)
	The supplied power voltage is not within the rating.	● Check controller power specifications, set power voltage within the rating range, and turn power ON again.	○
	The input signal exceeds the rating range.	● Check the controller input signal type, set the input signal within the rating range, and turn power ON again.	○
	An error occurred during EEPROM reading or writing.	● Contact your nearest CKD Sales Office or dealer.	
	An error occurred during memory reading or writing.	● Contact your nearest CKD Sales Office or dealer.	
	The flow rate did not reach the setting for five or more consecutive seconds.	<ul style="list-style-type: none"> ● Check the primary pressure, supply pressure within the rated operating differential pressure range, and turn power ON again. ● Check that there are no leaks from piping, joints, or other devices, correct connect pipes, and turn power ON again. ● Contact your nearest CKD Sales Office or dealer. 	○
	An output error is occurring in the sensor.	<ul style="list-style-type: none"> ● Stop the supply of fluids to the controller, set the flow rate to zero, and turn the controller power ON again. If this error occurs again, contact your nearest CKD Sales Office or dealer. 	○(Note 2)
	Switch output overcurrent protection circuit is activated.	● Check whether load current exceeds the rating, correctly connect the controller, and turn power ON again.	

Errors are basically automatically reset. However, if the error is not reset, turn power OFF, check the cause and correct the error. Then, turn power ON again.

Note 1: The default is error automatic shutoff set to OFF (valve fully closed if an error occurs). Refer to page 1368 for details.

Note 2: OFF (valve fully closed at error) regardless of the error automatic shutoff setting.

Controlling the flow rate

(1) Controlling the flow rate with direct memory

The target is input with keys. Even if input signals from an external source are not used, control flow rate is freely adjusted with controller operation keys. Direct memory has two operation modes.

- Direct memory (1): Settings are applied when the value is changed. (Even if the value is not set, the flow rate is adjusted by changing the value. This is handy for finely adjusting the flow rate. Set the setting value once the flow rate is determined.)
- Direct memory (2): Changes are applied when the value is set. (The flow rate does not change unless the value is set.)

<How to operate direct memory (1)>

- (1) Turn power ON. The instantaneous flow rate is displayed.
- (2) When the key is pressed, the <F1: Input signal confirmation> screen is displayed. The current input signal setting state is displayed. The current input signal type and input are alternately displayed. (The instantaneous flow rate display is displayed if 3 seconds pass without a button being pressed.)
- (3) "F1.dr" blinks when the key is held down for 2 seconds.
- (4) Hold down the key for 2 seconds and open the <Direct Memory 1 Setting screen>.
- (5) The flow rate changes when the value is change. The flow rate is adjusted by changing the value even if the value is not set.
- (6) Hold down the and keys simultaneously for 2 seconds, and set the value. The <F1: input signal confirmation> screen is displayed.
- (7) The instantaneous flow rate display is redisplayed after 3 seconds.

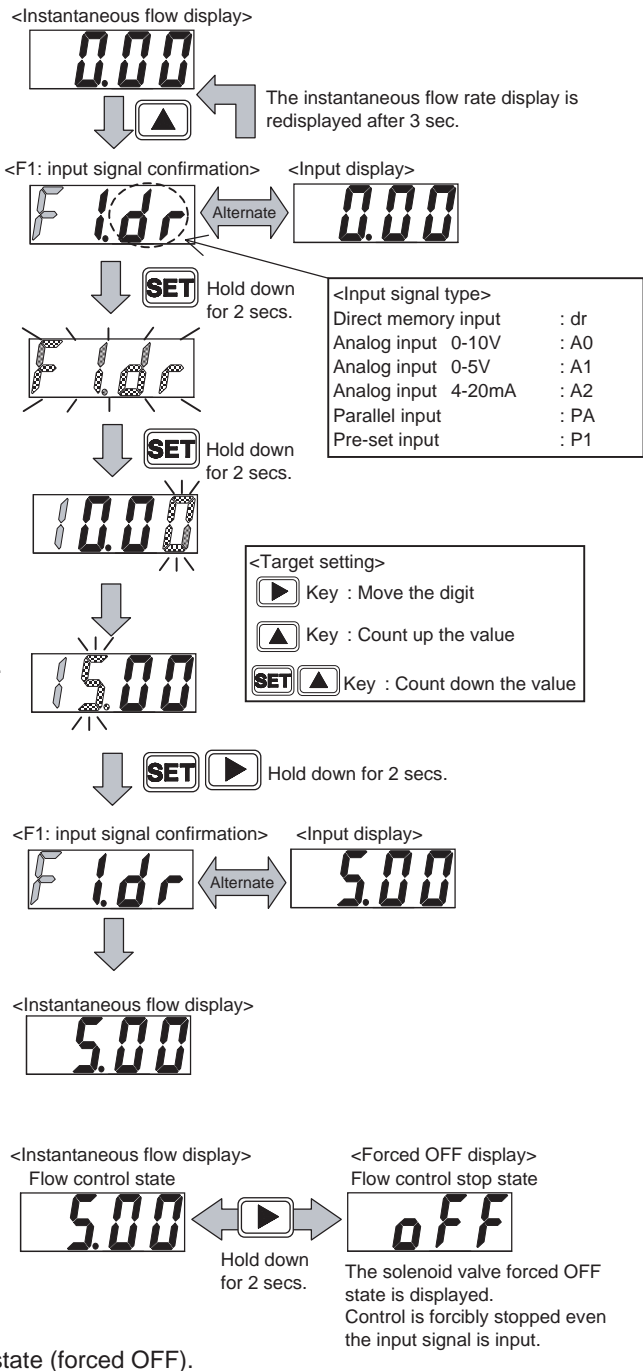
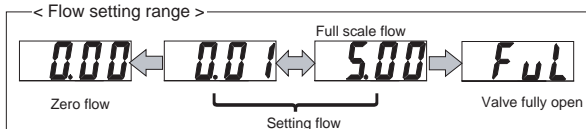

Forced OFF (flow rate zero)

The controller is forcibly stopped (flow rate zero) by holding down the key for 2 seconds in the flow control state (instantaneous flow rate display).

The flow control state is entered again by holding down the key for 2 seconds in the flow control stopped state (forced OFF).

Refrigerating type dryer
Desiccant type dryer
High polymer membrane dryer
Air filter
Auto. drain / others
F.R.L. (Module unit)
F.R.L. (Separate)
Compact F.R.
Precise regulator
F.R.L. (Related products)
Clean F.R.
Electro pneumatic regulator
Air booster
Speed control valve
Silencer
Check valve / others
Joint / tube
Vacuum filter
Vacuum regulator
Suction plate
Magnetic spring buffer
Mechanical pressure SW
Electronic pressure SW
Contact / close contact cont. SW
Air sensor
Pressure SW for coolant
Small flow sensor
Small flow controller
Flow sensor for air
Flow sensor for water
Total air system
Total air system (Gamma)

Ending

Small size flow controller

Controlling the flow rate

<How to operate direct memory (2)>

(1) Turn power ON. The instantaneous flow rate is displayed.

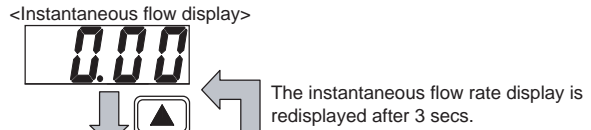

(2) When the key is pressed, the <F1: Input signal confirmation> screen is displayed. The current input signal setting state is displayed. The current input signal type and input are alternately displayed. (The instantaneous flow rate display is displayed if 3 seconds pass without a button being pressed.)

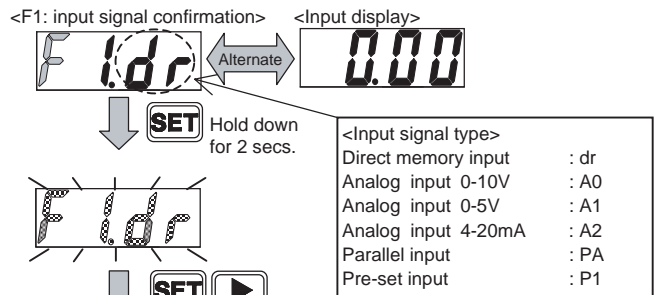

(3) "F1.dr" blinks when the key is held down for 2 seconds.

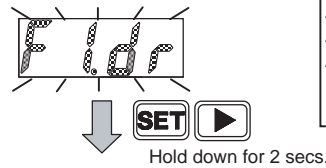

(4) Hold down the key for 2 seconds and open the <Direct Memory 1 Setting screen>.

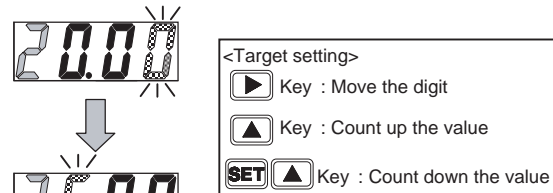

(5) Change the value. (The flow rate does not change unless the value is set.)



(6) Hold down the and keys simultaneously for 2 seconds, and set the value. The <F1: input signal confirmation> screen is displayed.

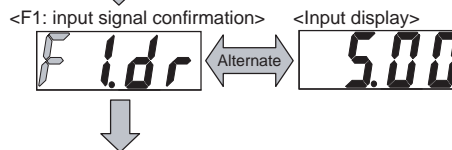

(7) The instantaneous flow rate display is redisplayed after 3 seconds.



Forced OFF (flow rate zero)

The controller is forcibly stopped (flow rate zero) by holding down the key for 2 seconds in the flow control state (instantaneous flow rate display).

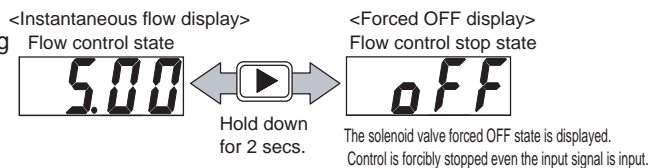

The flow control state is entered again by holding down the key for 2 seconds in the flow control stopped state (forced OFF).

CAUTION

- Control does not stop while setting direct memory. Take safety into consideration, and stop control (forced stop) if necessary.
- The flow control/forced OFF state (setting) is held even if power is turned OFF.

Controlling the flow rate

(2) Controlling the flow rate with preset input (only analog input)

When four random flow rate points are set, the flow rate is controlled by inputting a 2-bit signal from an external source.

E.g.) To control 0, 1, 2, and 5 l/min. with preset input, select Preset Input for the input setting mode, and set each of the following:
 P1: 0 l/min. P2: 1 l/min.
 P3: 2 l/min. P4: 5 l/min.
 When signals are input from a PLC, etc., as indicated in the table at right, the flow rate is controlled to each preset flow rate.

D-sub-socket pin No.	2	1	Pre-set memory No.
Cable option Isolator color	Orange	Brown	
Type of input	Bit 2	Bit 1	P1
Input signal	OFF	OFF	P1
	OFF	ON	P2
	ON	OFF	P3
	ON	ON	P4

<Controlling with the preset input signal>

- Turn power ON. The instantaneous flow rate is displayed.
- When the key is pressed, the <F1: Input signal confirmation> screen is displayed. The current input signal setting state is displayed. The current input signal type and input are alternately displayed. (The instantaneous flow rate display is displayed if 3 seconds pass without a button being pressed.)
- "F1.dr" blinks when the key is held down for 2 seconds.
- When the key is pressed twice, "F1.P1" will blink.
- Hold down the key for 2 seconds, and open the P1 setting confirmation screen.
- Hold down the key for 2 seconds, and open the target input screen. Input the target.
- When the and key are held down for 2 seconds, the target is set in memory, and the P2 setting confirmation screen is displayed. Set all of the targets up to P4 with this.
- The instantaneous flow rate display is redisplayed after 3 seconds. The flow is controlled with preset input.

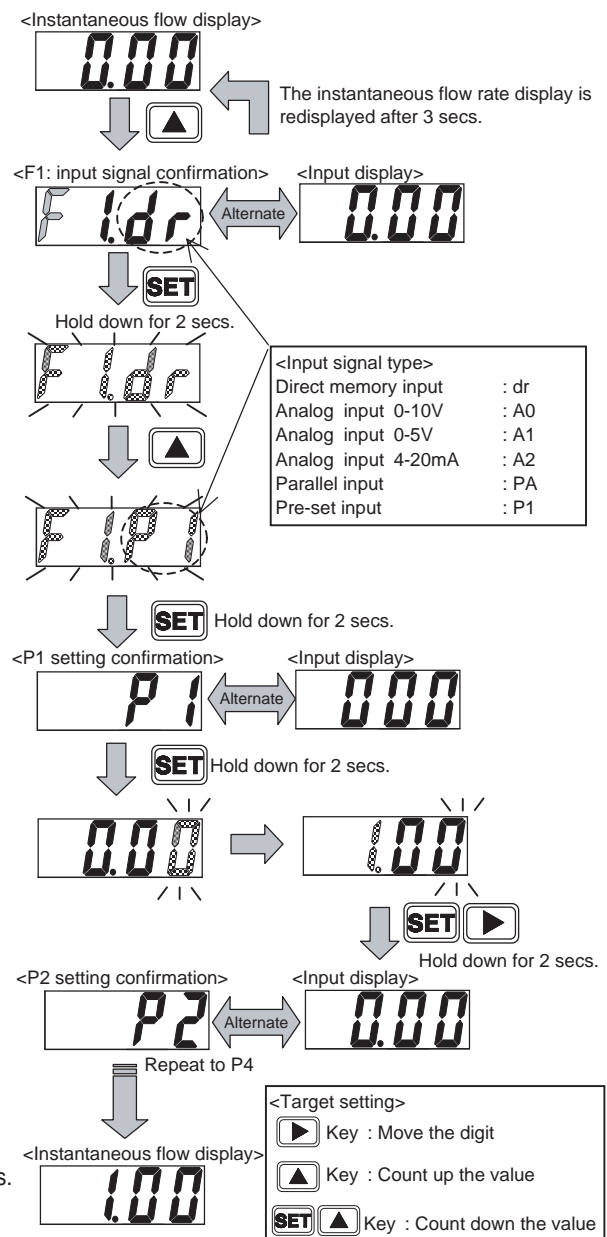

Refrigerating type dryer
Desiccant type dryer
High polymer membrane dryer
Air filter
Auto. drain / others
F.R.L. (Module unit)
F.R.L. (Separate)
Compact F.R.
Precise regulator
F.R.L. (Related products)
Clean F.R.
Electro pneumatic regulator
Air booster
Speed control valve
Silencer
Check valve / others
Joint / tube
Vacuum filter
Vacuum regulator
Suction plate
Magnetic spring buffer
Mechanical pressure SW
Electronic pressure SW
Contact / close contact cont. SW
Air sensor
Pressure SW for coolant
Small flow sensor
Small flow controller
Flow sensor for air
Flow sensor for water
Total air system
Total air system (Gamma)
Ending

Small size flow controller

Controlling the flow rate

(3) Changing settings with shortcut keys (only when using direct memory and preset input)

When controlling the flow using direct memory or preset input, the setting change screen is opened with a single key operation.

Note: The input signal setting change screen opens the instant that the shortcut key is pressed.
 (Example: The P2 setting change screen opens when controlling the flow with the preset input P2.)
 This cannot be used when controlling the flow with analog input or parallel input.

<Changing the setting with a shortcut>

(1) Turn power ON. The instantaneous flow rate is displayed.

(This is used only when controlling with direct memory or preset input.)

<Instantaneous flow display>



Control when flowing with preset memory P2



Hold down for 3 secs.

<F1: input signal confirmation> and <input display> are alternately displayed during this time.



<Target setting>	
	Key : Move the digit
	Key : Count up the value
	Key : Count down the value

(2) When the key is held down for 3 seconds, and the key is pressed, the input signal setting change screen is displayed.



(3) The flow rate changes when the value is change.
 The flow rate is adjusted by changing the value even if the value is not set.



Hold down for 2 secs.

(4) Hold down the and keys simultaneously for 2 seconds, and set the value.

<F1: input signal confirmation>



<Input display>



The <F1: input signal confirmation> screen is displayed.

(5) The instantaneous flow rate display is redisplayed after 3 seconds.

<Instantaneous flow display>



Note: Do not change the preset external input while changing the setting with the shortcut key.
 The setting could be set into an incorrect preset No.

Data is not saved in memory if power is turned OFF before setting the value. Set the value before turning power OFF.

Refrigerating type dryer
Desiccant type dryer
High polymer membrane dryer
Air filter
Auto. drain / others
F.R.L. (Module unit)
F.R.L. (Separate)
Compact F.R.
Precise regulator
F.R.L. (Related products)
Clean F.R.
Electro pneumatic regulator
Air booster
Speed control valve
Silencer
Check valve / others
Joint / tube
Vacuum filter
Vacuum regulator
Suction plate
Magnetic spring buffer
Mechanical pressure SW
Electronic pressure SW
Contact / close contact conf. SW
Air sensor
Pressure SW for coolant
Small flow sensor
Small flow controller
Flow sensor for air
Flow sensor for water
Total air system
Total air system (Gamma)
Ending

Controlling the flow rate

(4) Controlling the flow rate with analog input (Only analog input)



The flow rate is controlled with analog input signals.

<Controlling with analog input signals>

(1) Turn power ON. The instantaneous flow rate is displayed.

(2) When the  key is pressed, the <F1: Input signal confirmation> screen is displayed. The current input signal setting state is displayed. The current input signal type and input are alternately displayed. (The instantaneous flow rate display is displayed if 3 seconds pass without a button being pressed.)

(3) "F1.dr" blinks when the  key is held down for 2 seconds.

(4) When the  key is pressed once, "F1.A 0" will blink. (The number shown with  differs based on the model.)

(5) Hold down the  key for 2 seconds and set the value. The <F1: input signal confirmation> screen is displayed.

(6) The instantaneous flow rate display is redisplayed after 3 seconds. The flow rate is controlled with analog input.

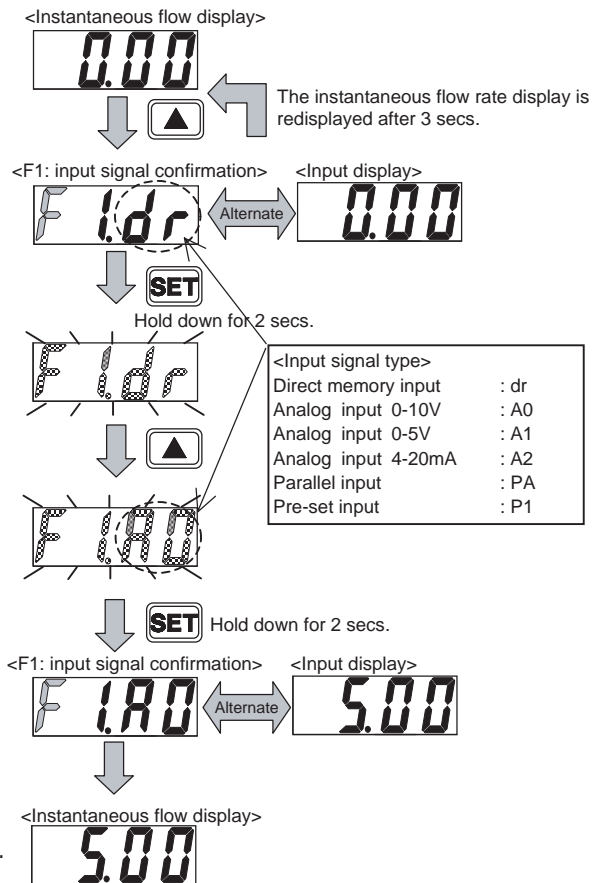

Note: Fully open (FUL) cannot be set with analog input.

Refrigerating type dryer
Desiccant type dryer
High polymer membrane dryer
Air filter
Auto. drain / others
F.R.L. (Module unit)
F.R.L. (Separate)
Compact F.R.
Precise regulator
F.R.L. (Related products)
Clean F.R.
Electro pneumatic regulator
Air booster
Speed control valve
Silencer
Check valve / others
Joint / tube
Vacuum filter
Vacuum regulator
Suction plate
Magnetic spring buffer
Mechanical pressure SW
Electronic pressure SW
Contact / close contact cont. SW
Air sensor
Pressure SW for coolant
Small flow sensor
Small flow controller
Flow sensor for air
Flow sensor for water
Total air system
Total air system (Gamma)

Ending

Small size flow controller

Controlling the flow rate

(5) Controlling the flow rate with parallel input (Only parallel input)

The flow rate is controlled with a parallel 10-bit (signal from PLC, etc.). Expensive input/output devices, such as a D/A converter, are not required. The parallel input signal is a 10-point signal so when converted to a decimal, it becomes 0-1023. A 0.1% resolution is attained.

Input signal = setting flow/full scale flow x 1023

Example) To set 300 mℓ/min. with a full-scale flow rate 500 mℓ/min.

$$300 \text{ (mℓ/min.)} / 500 \text{ (mℓ/min.)} \times 1023 = 613.8 \rightarrow 614$$

When 614 (decimal) is converted to binary, it becomes 1001100110. 1 sets the input signal ON, and 0 sets the input signal OFF. (Refer to the below table)

D-sub-socket pin No.	12	11	9	8	7	6	4	3	2	1
Cable option Isolator color	Green (Black line)	White	Red (Black line)	White (Black line)	Pink	Light blue	Purple	Yellow	Orange	Brown
Type of input	Bit 10 MSB	Bit 9	Bit 8	Bit 7	Bit 6	Bit 5	Bit 4	Bit 3	Bit 2	Bit 1 LSB
Binary (For 614 [decimal])	1	0	0	1	1	0	0	1	1	0
Input signal	ON	OFF	OFF	ON	ON	OFF	OFF	ON	ON	OFF

<Controlling with parallel input signals>

(1) Turn power ON. The instantaneous flow rate is displayed.

(2) When the  key is pressed, the <F1: Input signal confirmation> screen is displayed. The current input signal setting state is displayed. The current input signal type and input are alternately displayed. (The instantaneous flow rate display is displayed if 3 seconds pass without a button being pressed.)

(3) "F1.dr" blinks when the  key is held down for 2 seconds.

(4) When the  key is pressed once, "F1.PA" will blink.

(5) Hold down the  key for 2 seconds and set the value. The <F1: input signal confirmation> screen is displayed.

(6) The instantaneous flow rate display is redisplayed after 3 seconds. The flow rate is controlled with parallel input.

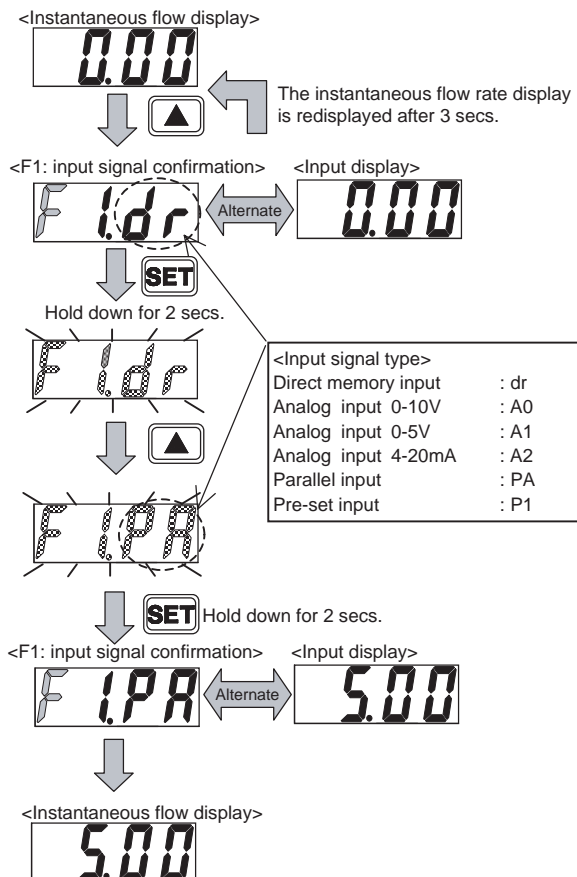

Note: Fully open (FUL) cannot be set with parallel input.

<References>

If a high resolution is not required, the number of input points is reduced.

E.g.) If 2% resolution is acceptable, operate with a 6-point input (0-63 when converted to decimal).

Bits 5 to 1 in the above table are shorted in a bundle. When turned ON and OFF as one bit (LSB), control is executed with 6 points.

Integrating the flow rate

(1) Displaying the integrated flow

The flow rate is integrated and displayed. The display range is shown below.

Model no. FCM-		9500 L9500	0001 L0001	0002 L0002	0005 L0005	0010 L0010	0020	0050	0100
Flow display	Display range	0 to 500 ml /min	0.00 to 1.00 l/min	0.00 to 2.00 l/min	0.00 to 5.00 l/min	0.0 to 10.0 l/min	0.0 to 20.0 l/min	0.0 to 50.0 l/min	0 to 100 l/min
Function of integration	Display range	999999 ml	9999.99 l	9999.99 l	9999.99 l	99999.9 l	99999.9 l	99999.9 l	999999 l
	Display resolution	1ml	0.01 l	0.01 l	0.01 l	0.1l	0.1l	0.1l	1l
	Pulse output rate	5ml	0.01 l	0.02 l	0.05 l	0.1l	0.2l	0.5l	1l

< Display of integration >

- Instantaneous flow rate display**
Integration starts when power is turned ON.
(The integrated value is reset when power is turned OFF.)
- The display of integration screen opens when the **SET** key is held down for 2 seconds.**
Press the **SET** key for 2 seconds to return to the instantaneous flow rate display. The display digit changes when the **▶** key is pressed.
- Integration is reset when the **SET** and **▶** keys are held down for 2 seconds.** With analog input type, integration is reset with the external input (No. 3 pin). Integration is also reset when power is turned OFF.

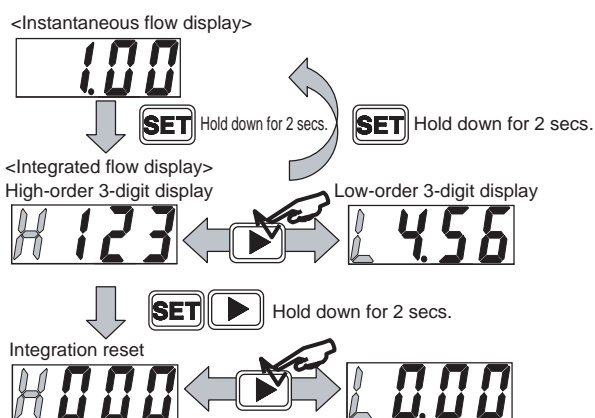

(2) Closing and stopping the solenoid valve with set integrated flow

The solenoid valve is closed and stopped when the set integrated flow is attained. This is suitable for processes in which a set amount is supplied, etc.

<Operation>

- Instantaneous flow rate display**
- Press the **▲** key five times and open the <F5: integration automatic shutoff setting screen>.**
If integration automatic shutoff is valid, "F5.on" and the current setting are alternately displayed. (The instantaneous flow rate display is displayed if 3 seconds pass without a button being pressed.)
- When the **SET** key is held down for 2 seconds, "F5.--" blinks.**
When not using integration automatic shutoff, hold down the **SET** key for 2 seconds. The <F5 screen> is redisplayed, and after 3 seconds, the instantaneous flow rate screen is displayed.
- To use integration automatic shutoff, press the **▲** key so that "F5.on" blinks.**
Then, hold down the **SET** key for 2 seconds.
After setting the high-order digit, hold down the **SET** and **▶** key for 2 seconds.
After setting the low-order digit, hold down the **SET** key and **▶** key for 2 seconds.
The <F5 screen> is displayed, and after 3 seconds, the instantaneous flow rate screen is displayed.

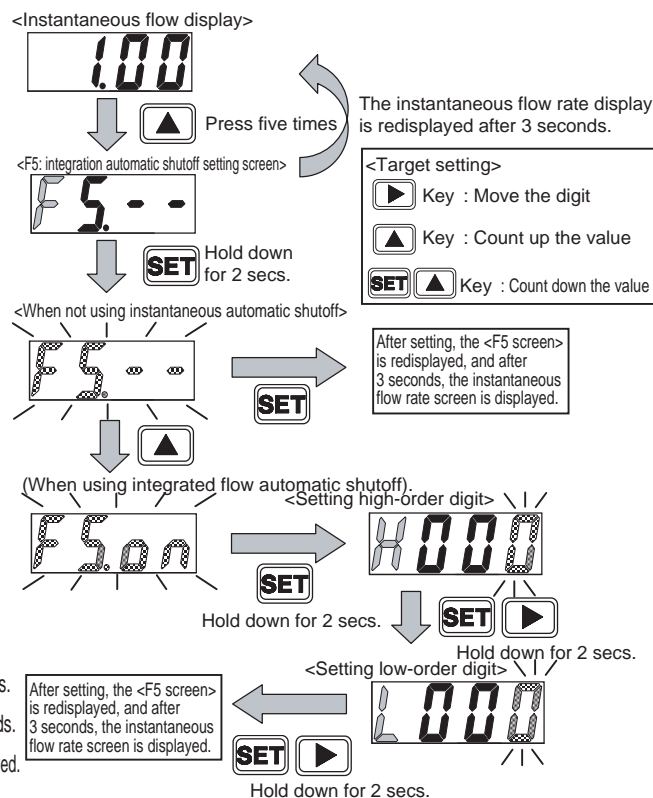

- * Only in this mode, the integrated value is reset when the input signal reaches zero. (Valid only after automatic shutoff)
- * The solenoid valve is automatically shut off, and this operates a switch when the set integrated flow is reached.
- * If the display for automatic shutoff is "OFF", the switch output lamp does not turn ON. The flow rate display is redisplayed when the integrated value is reset (button operation or external input).
- * Even if automatic shutoff is invalidated during automatic shutoff, it does not function until the integrated value is reset.
- * The integrated value is reset when automatic shutoff is set to "on" and the value is set.





Integrating the flow rate

(3) Outputting the integrated pulse (only switch output)

The integrated pulse is output. Refer to the table on page 1361 for the pulse rate.

Refer to the connection method (page 1350), examples of internal circuit and load connection (pages 1351 and 1352) for details on connecting switch output.

<Operation>

- (1) Instantaneous flow rate display
- (2) Press the  key four times and open the <F4: switch output setting screen>. If switch output setting is valid, "F4.□" and the current setting are alternately displayed. (The instantaneous flow rate display is displayed if 3 seconds pass without a button being pressed.)
- (3) Hold down the  key for 2 seconds, and enter switch output setting mode.
- (4) When the  key is pressed three times, "F4.3" blinks. When the  key is held down for 2 seconds, the integrated pulse output is set. The <F4 screen> is redisplayed, and after 3 seconds, the instantaneous flow rate screen is displayed.

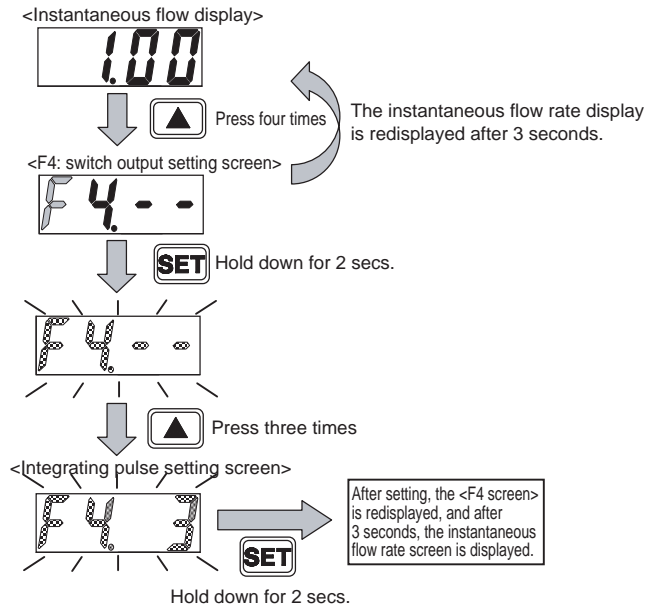









(4) Turning the set integrated flow ON with a switch (only switch output)

Switch output is turned ON at the set integrated flow.

Refer to the connection method (page 1350), examples of internal circuit and load connection (pages 1351 and 1352) for details on connecting switch output.

<Operation>

- (1) Instantaneous flow rate display
- (2) Press the  key four times and open the <F4: switch output setting screen>. If switch output setting is valid, "F4.□" and the current setting are alternately displayed. (The instantaneous flow rate display is displayed if 3 seconds pass without a button being pressed.)
- (3) Hold down the  key for 2 seconds, and enter switch output setting mode.
- (4) When the  key is pressed four times, "F4.4" blinks. Hold down the  key for 2 seconds, and open the target setting screen. After setting the high-order 3 digits of the target, hold down the  and  keys for 2 seconds. After setting the low-order 3 digits of the target, hold down the  and  keys for 2 seconds. The integrated value is reset after the target is set.
- (5) The <F4 screen> is redisplayed, and after 3 seconds, the instantaneous flow rate screen is displayed.

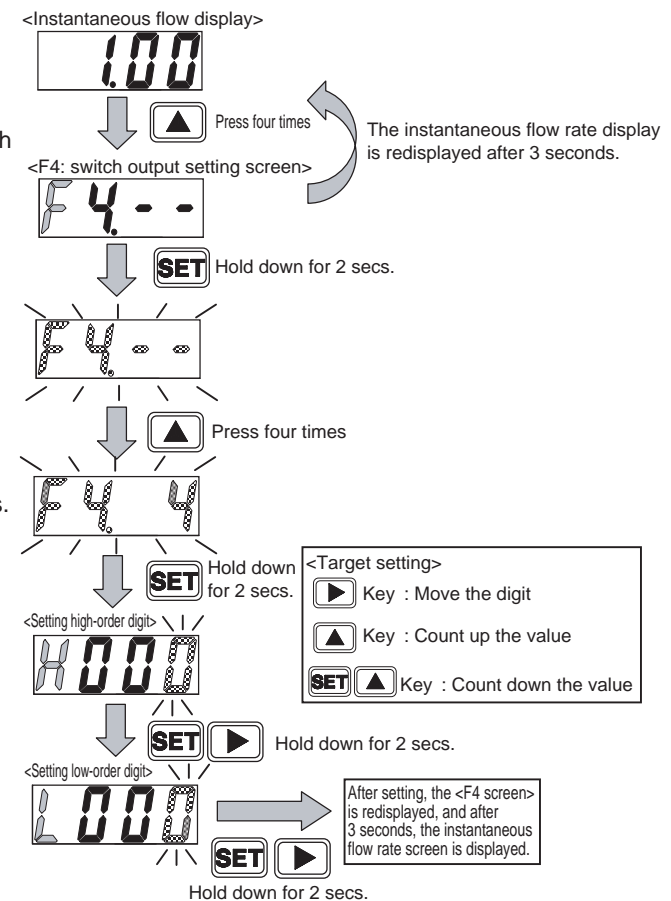

Using switch output (only switch output)

(1) Using the tolerance mode

Switch output turns ON when the level is within the tolerance of the input signal setting.

The tolerance is set for both the plus side and minus side as a %FS (full-scale).

Refer to the connection method (page 1350), examples of internal circuit and load connection (pages 1351 and 1352) for details on connecting switch output.

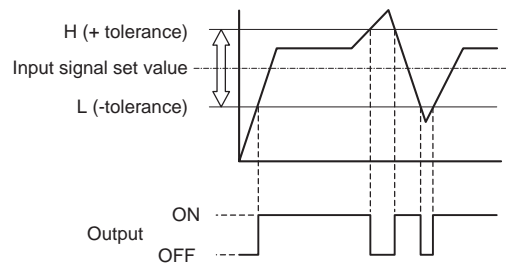

<Operation>

- (1) Instantaneous flow rate display
- (2) Press the key four times and open the <F4: switch output setting screen>. If switch output setting is valid, "F4.□" and the current setting are alternately displayed. (The instantaneous flow rate display is displayed if 3 seconds pass without a button being pressed.)
- (3) Hold down the key for 2 seconds, and enter switch output setting mode.
- (4) When the key is pressed once, "F4.1" blinks. Hold down the key for 2 seconds, and open the target setting screen.
- (5) After setting the tolerance (minus side), hold down the and keys for 2 seconds. Minus side setting range: -50 to 0%FS
- (6) After setting the tolerance (plus side), hold down the and keys for 2 seconds. Plus side setting range: 0 to 50%FS
- (7) The <F4 screen> is redisplayed, and after 3 seconds, the instantaneous flow rate screen is displayed.

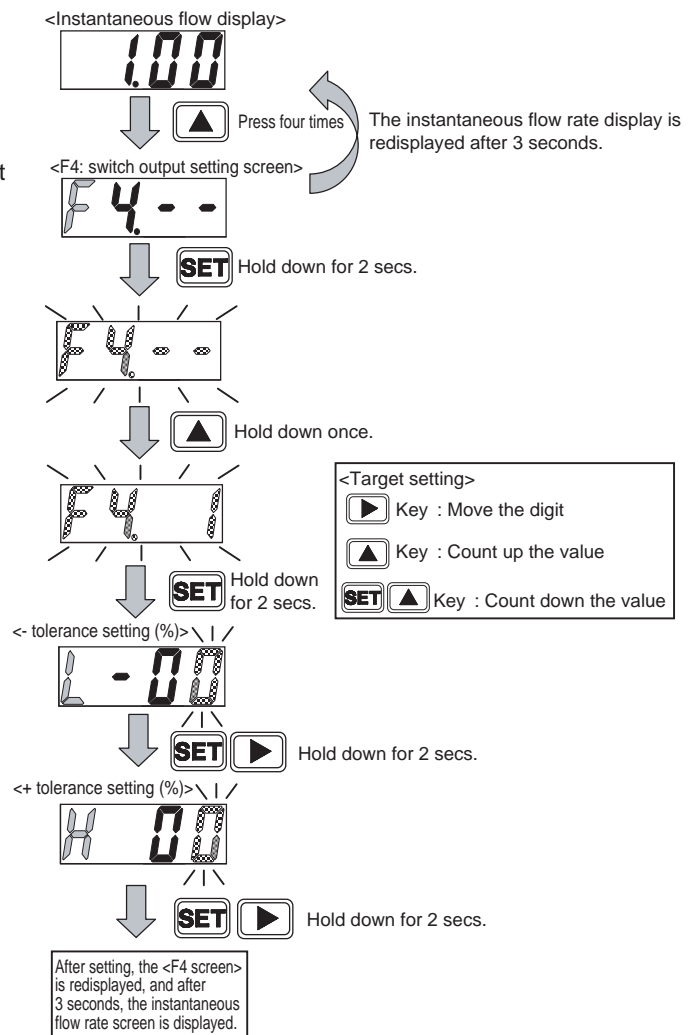

Refrigerating type dryer
Desiccant type dryer
High polymer membrane dryer
Air filter
Auto. drain / others
F.R.L. (Module unit)
F.R.L. (Separate)
Compact F.R.
Precise regulator
F.R.L. (Related products)
Clean F.R.
Electro pneumatic regulator
Air booster
Speed control valve
Silencer
Check valve / others
Joint / tube
Vacuum filter
Vacuum regulator
Suction plate
Magnetic spring buffer
Mechanical pressure SW
Electronic pressure SW
Contact / close contact cont. SW
Air sensor
Pressure SW for coolant
Small flow sensor
Small flow controller
Flow sensor for air
Flow sensor for water
Total air system
Total air system (Gamma)

Ending

Small size flow controller

Using switch output (only switch output)

(2) Using the range designation mode

The switch turns ON when the level is not within the designated flow rate range. The upper and lower limit values are set regardless of the input signal setting (control target).

Both the upper limit and lower limit are set as % FS (full-scale).

Refer to the connection method (page 1350), examples of internal circuit and load connection (pages 1351 and 1352) for details on connecting switch output.

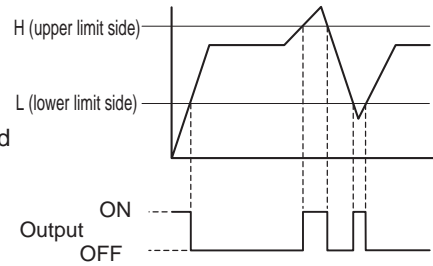

<Operation>

- (1) Instantaneous flow rate display
- (2) Press the key four times and open the <F4: switch output setting screen>. If switch output setting is valid, "F4.□" and the current setting are alternately displayed. (The instantaneous flow rate display is displayed if 3 seconds pass without a button being pressed.)
- (3) Hold down the key for 2 seconds, and enter switch output setting mode.
- (4) When the key is pressed twice, "F4.2" blinks. Hold down the key for 2 seconds, and open the target setting screen.
- (5) After setting the lower limit value, hold down the and keys for 2 seconds. Lower limit setting range: 0 to 90%FS
- (6) After setting the upper limit value, hold down the and keys for 2 seconds. Plus side setting range: 10 to 100%FS
Note that the gap between the upper and lower limits must be 10% FS or more.
- (7) The <F4 screen> is redisplayed, and after 3 seconds, the instantaneous flow rate screen is displayed.

<Instantaneous flow display>

Press four times

The instantaneous flow rate display is redisplayed after 3 seconds.

<F4: switch output setting screen>

Hold down for 2 secs.

Hold down twice

Hold down for 2 secs.

<Lower limit setting (%)> |

Hold down for 2 secs.

<Upper limit setting (%)> | /

Hold down for 2 secs.

After setting, the <F4 screen> is redisplayed, and after 3 seconds, the instantaneous flow rate screen is displayed.

<Target setting>	
	Key : Move the digit
	Key : Count up the value
	Key : Count down the value

Operation (List)

- CAUTION:**
- Keys are unlocked when the controller is shipped. Lock keys if necessary. The key lock/unlock state is held even if power is turned OFF.
 - Control does not stop during the F1: input signal selection or F2: input signal zero/span setting. Take safety into consideration and stop control (forced stop) if necessary.
 - The flow control/forced OFF state is held even if power is turned OFF.

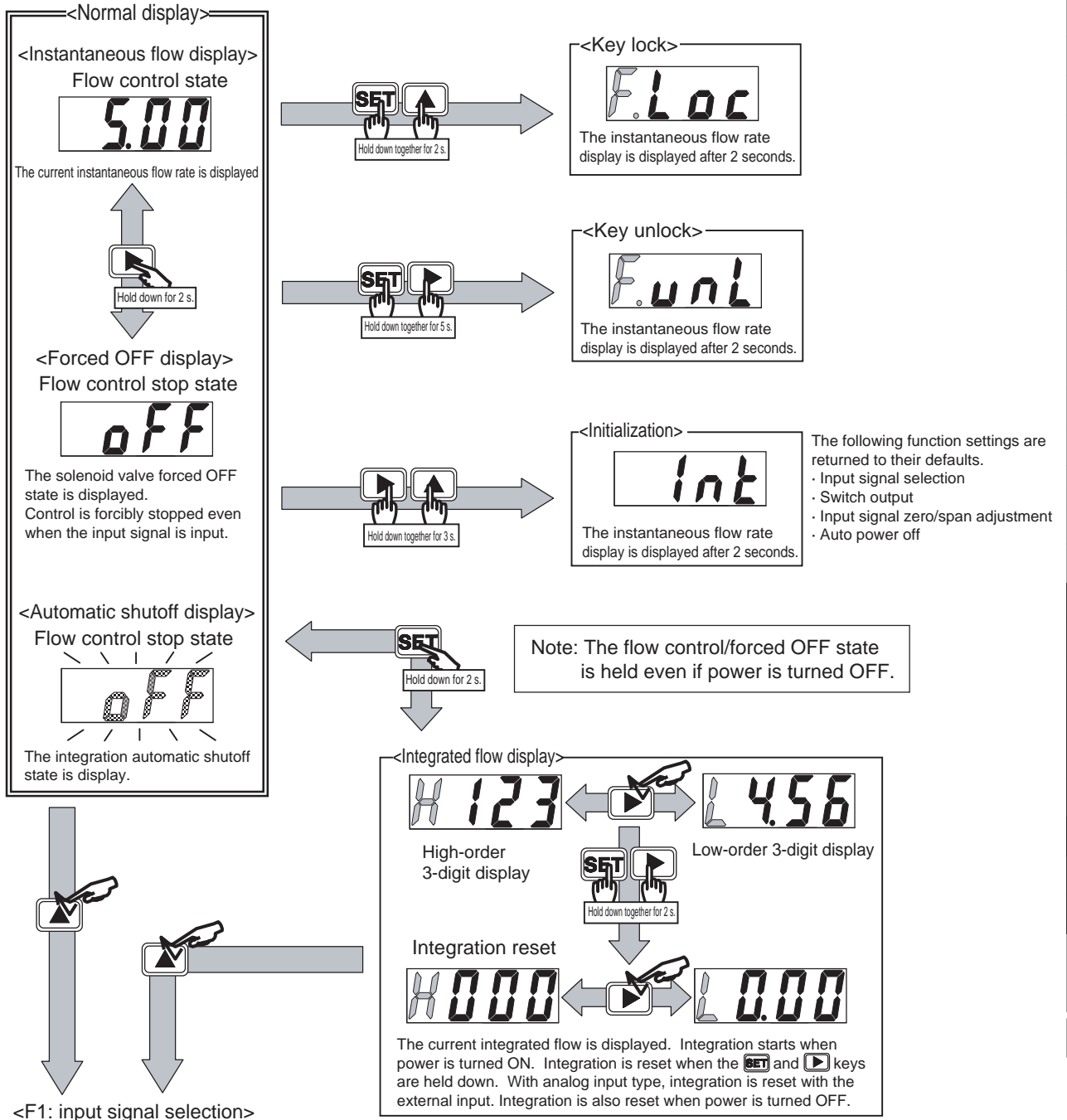

Refrigerating type dryer
Desiccant type dryer
High polymer membrane dryer
Air filter
Auto. drain / others
F.R.L. (Module unit)
F.R.L. (Separate)
Compact F.R.
Precise regulator
F.R.L. (Related products)
Clean F.R.
Electro pneumatic regulator
Air booster
Speed control valve
Silencer
Check valve / others
Joint / tube
Vacuum filter
Vacuum regulator
Suction plate
Magnetic spring buffer
Mechanical pressure SW
Electronic pressure SW
Contact / close contact cont. SW
Air sensor
Pressure SW for coolant
Small flow sensor
Small flow controller
Flow sensor for air
Flow sensor for water
Total air system
Total air system (Gamma)
Ending

Small size flow controller

Operation (List)

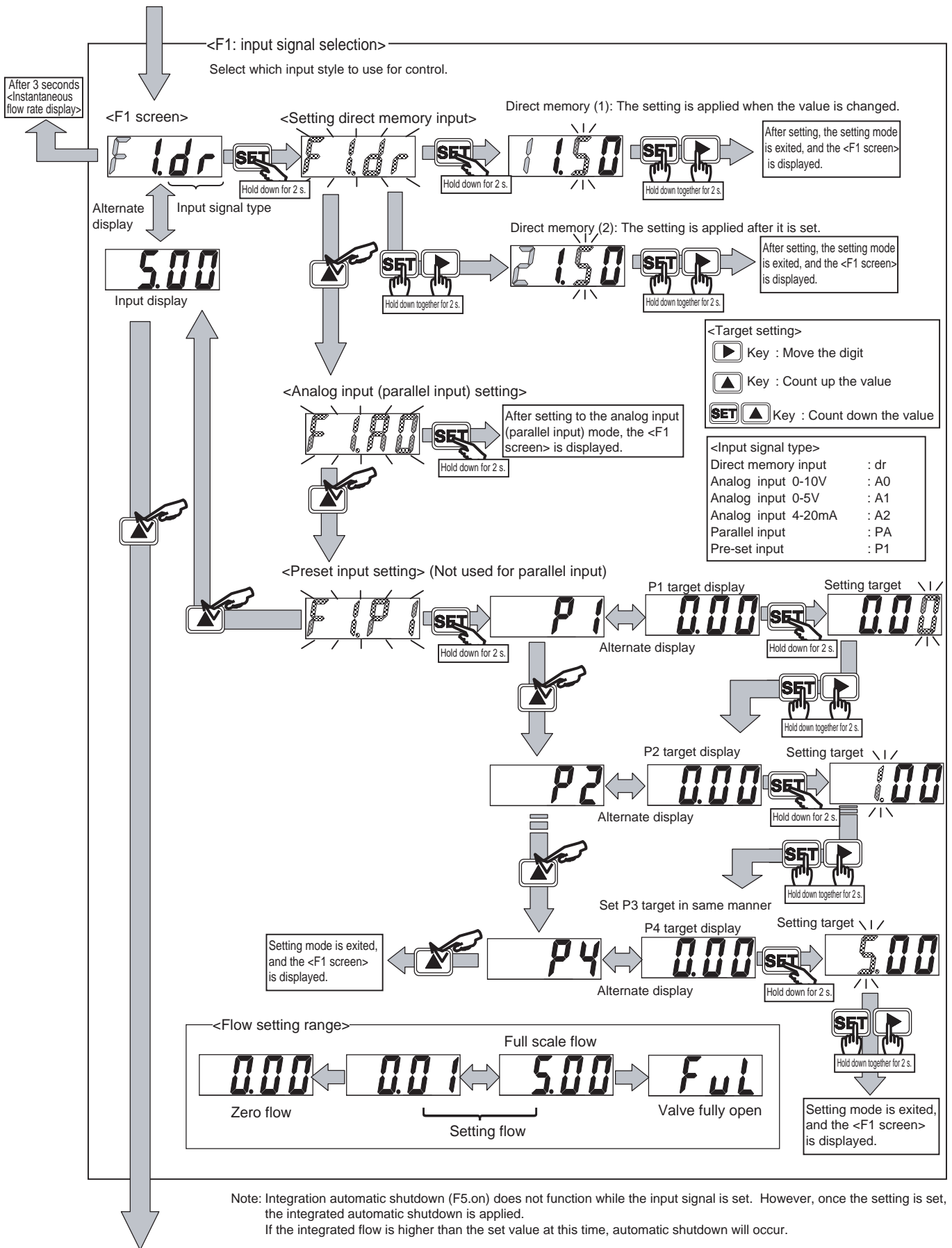

<F2: input signal zero/span adjustment>

Operation (List)

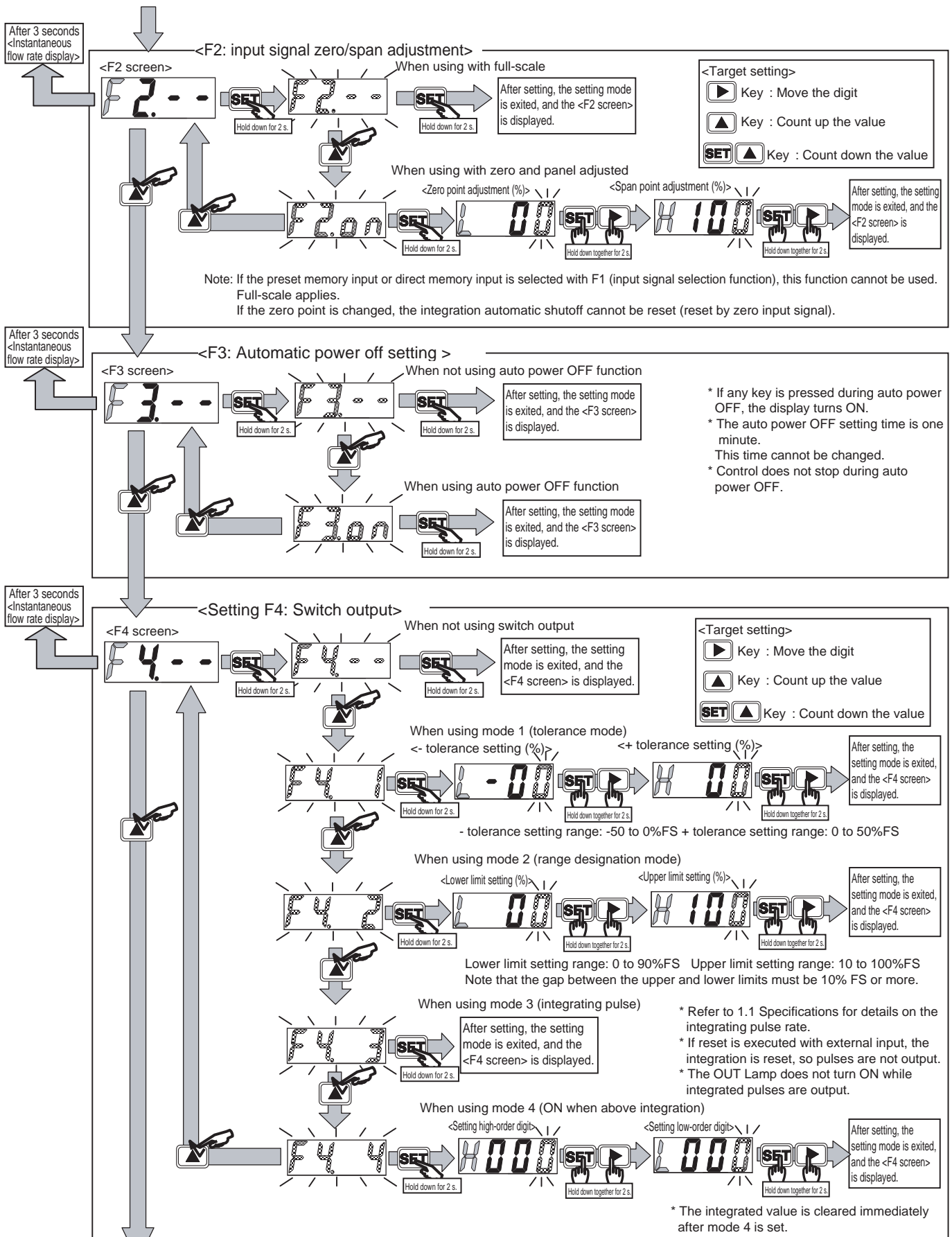

Note: Switch output setting mode cannot be entered with the analog output.
 <F5: Integrated automatic shutoff setting screen>

Refrigerating type dryer
Desiccant type dryer
High polymer membrane dryer
Air filter
Auto. drain / others
F.R.L. (Module unit)
F.R.L. (Separate)
Compact F.R.
Precise regulator
F.R.L. (Related products)
Clean F.R.
Electro pneumatic regulator
Air booster
Speed control valve
Silencer
Check valve / others
Joint / tube
Vacuum filter
Vacuum regulator
Suction plate
Magnetic spring buffer
Mechanical pressure SW
Electronic pressure SW
Contact / close contact cont. SW
Air sensor
Pressure SW for coolant
Small flow sensor
Small flow controller
Flow sensor for air
Flow sensor for water
Total air system
Total air system (Gamma)
Ending
Small size flow controller

Operation (List)

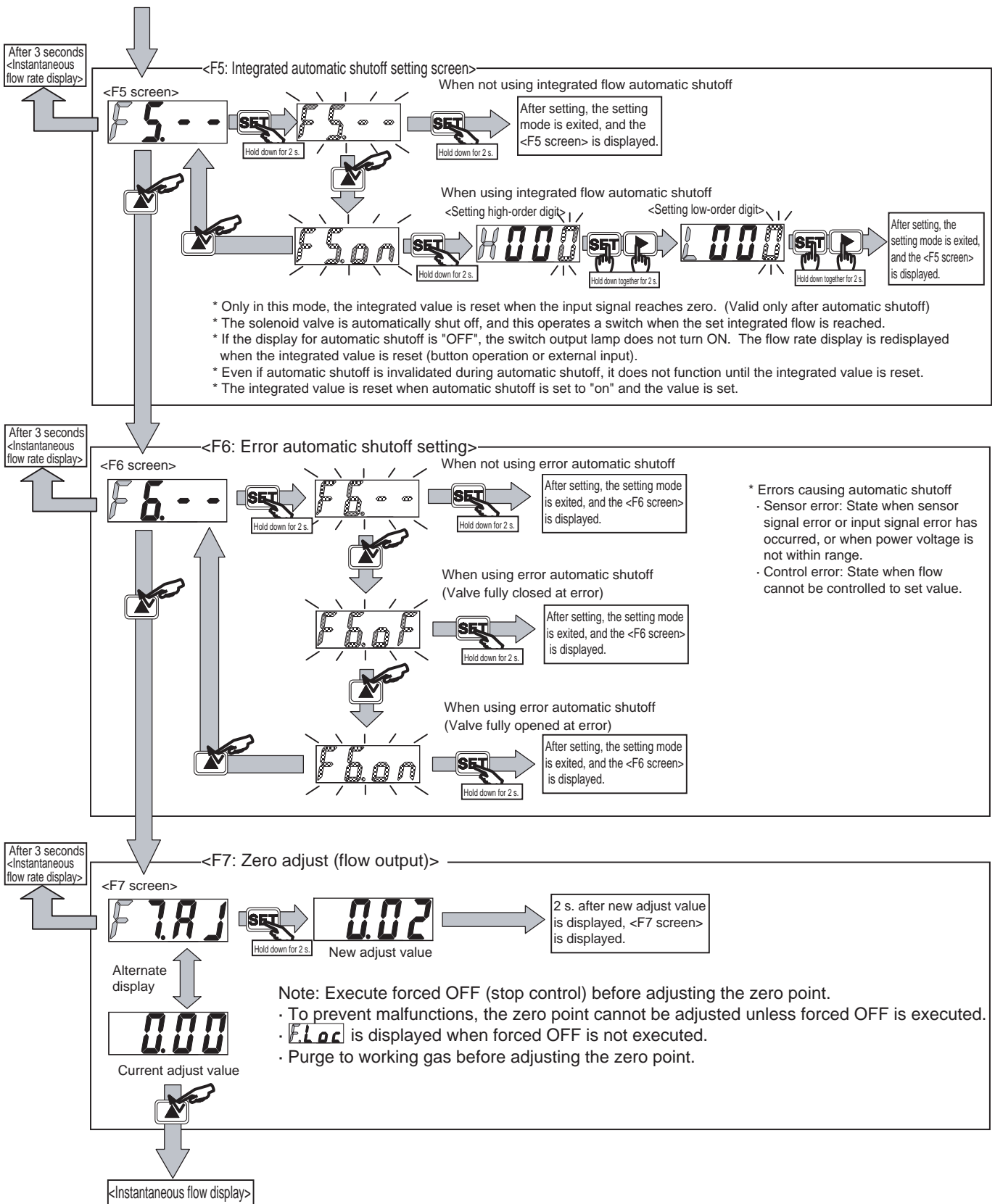

- Refrigerating type dryer
- Desiccant type dryer
- High polymer membrane dryer
- Air filter
- Auto. drain / others
- F.R.L. (Module unit)
- F.R.L. (Separate)
- Compact F.R.
- Precise regulator
- F.R.L. (Related products)
- Clean F.R.
- Electro pneumatic regulator
- Air booster
- Speed control valve
- Silencer
- Check valve / others
- Joint / tube
- Vacuum filter
- Vacuum regulator
- Suction plate
- Magnetic spring buffer
- Mechanical pressure SW
- Electronic pressure SW
- Contact / close contact conf. SW
- Air sensor
- Pressure SW for coolant
- Small flow sensor
- Small flow controller
- Flow sensor for air
- Flow sensor for water
- Total air system
- Total air system (Gamma)
- Ending

Custom

Custom-order parts with the following functions are used. Contact the CKD Sales Office for details.

8-point preset input

This type is compatible with eight preset points (3 bit). (The external integration reset signal input cannot be used.)

Oil-prohibited specifications (only stainless steel body)

Oil-prohibited specifications are available for the stainless steel type, excluding the oxygen model.

Refrigerating type dryer
Desiccant type dryer
High polymer membrane dryer
Air filter
Auto. drain / others
F.R.L. (Module unit)
F.R.L. (Separate)
Compact F.R.
Precise regulator
F.R.L. (Related products)
Clean F.R.
Electro pneumatic regulator
Air booster
Speed control valve
Silencer
Check valve / others
Joint / tube
Vacuum filter
Vacuum regulator
Suction plate
Magnetic spring buffer
Mechanical pressure SW
Electronic pressure SW
Contact / close contact cont. SW
Air sensor
Pressure SW for coolant
Small flow sensor
Small flow controller
Flow sensor for air
Flow sensor for water
Total air system
Total air system (Gamma)

Ending

Small size flow controller